

# M12 Steckverbinder für Schlauchanschluss / M12 plugging connectors for hose connection

**Kontakte: Schraubklemmen /**  
contacts: screwing clamps

**Schlauchanschluss möglich:  
Druckschrauben entfernen und  
Schlauchverschraubung einschrauben /**  
hose connection possible: remove pressure screw and  
screw in hose fitting

**Kodierung / coding:** A  
**Nennspannung / rating voltage:** 4 Pole - 250 V; 5 Pole - 60 V  
**Nennstrom / rating current:** 4 A  
**Temperaturbereich / temperature range:** -40°C - +85°C  
**Isolationswiderstand / isolation resistance:**  $\geq 10^8 \Omega$   
**Kontaktwiderstand / contact resistance:**  $\leq 5m\Omega$   
**Mechanische Lebensdauer / mechanical lifespan:** max. 100 Steckzyklen / max. 100 cycles  
**Schutzart / protection grade:** IP67 nach / acc. to IEC 61076-2-101  
**Material Gehäuse / material housing:** Polyamid / polyamide 66 GF25 /  
**Material Kontakt / material contact:** Messing vernickelt / nickel plated brass  
**Kontaktoberfläche / contact surface:** vergoldet / gold plated  
**Material Kontaktkörper / material contact body:** PA  
**Material Dichtung / material sealing:** Silikon / silicone

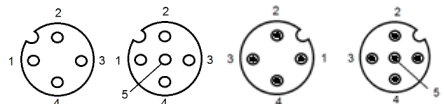

## GOGAPLUG M12 Buchse gerade / straight M12 socket

Pole	max. Kabel Ø mm	Gewinde	ArtNr	€/Stk.
pole	max. cable Ø	thread	part no.	/pc.
4	4 - 6	PG7	34-W12F4A2-007-A	11,24
	6 - 8	PG9	34-W12F4A2-009-A	11,24
5	4 - 6	PG7	34-W12F5A2-007-A	12,91
	6 - 8	PG9	34-W12F5A2-009-A	12,91

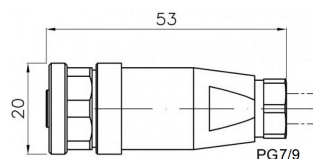

## GOGAPLUG M12 Stift gerade / straight M12 plug

Pole	max. Kabel Ø mm	Gewinde	ArtNr	€/Stk.
pole	max. cable Ø	thread	part no.	/pc.
4	4 - 6	PG7	34-W12M4A2-007-A	9,66
	6 - 8	PG9	34-W12M4A2-009-A	a.A.
5	4 - 6	PG7	34-W12M5A2-007-A	10,8
	6 - 8	PG9	34-W12M5A2-009-A	11,88

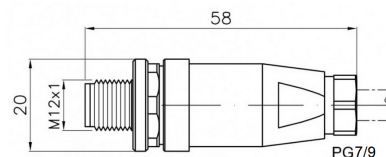

a. A. = auf Anfrage / upon request

## GOGAPLUG M12 Buchse gewinkelt / angled M12 socket

Pole	max. Kabel Ø mm	Gewinde	ArtNr	€/Stk.
pole	max. cable Ø	thread	part no.	/pc.
4	4 - 6	PG7	34-W12F4B2-007-A	11,58
	6 - 8	PG9	34-W12F4B2-009-A	a.A.
5	4 - 6	PG7	34-W12F5B2-007-A	13,21
	6 - 8	PG9	34-W12F5B2-009-A	13,21

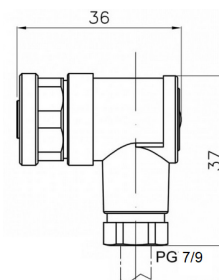

a. A. = auf Anfrage / upon request

## GOGAPLUG M12 Stift gewinkelt / angled M12 plug

Pole	max. Kabel Ø mm	Gewinde	ArtNr	€/Stk.
pole	max. cable Ø	thread	part no.	/pc.
4	4 - 6	PG7	34-W12M4B2-007-A	9,66
	6 - 8	PG9	34-W12M4B2-009-A	a.A.
5	4 - 6	PG7	34-W12M5B2-007-A	11,24
	6 - 8	PG9	34-W12M5B2-009-A	11,24

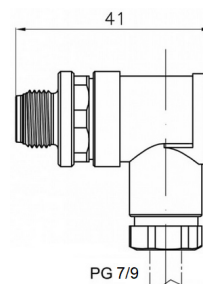

a. A. = auf Anfrage / upon request

## Passende Schlauchverschraubung / suitable hose fitting:

Typ	Länge mm	Gewinde länge mm	Innen-Ø mm	Außen-Ø mm	Schlüssel- weite mm	VPE Stk.	ArtNr grau	ArtNr schwarz	€/Stk.
type	length	thread length	inside-Ø	outside-Ø	spanner size	PU	grey	black	/pc.
PA-K1 PG7/7,5	24,3	7,0	8,5	15,2	14	50	245500	245500SW	1,34
PA-K1 PG9/7,5	26,1	7,3	8,4	17,3	14	50	245502	245502SW	1,37
PA-K1 PG9/10	28,0	7,6	10,5	19,8	19	50	245504	245504SW	1,37



Preise gültig ab 01.01.2024 exkl. MwSt., freibleibend, Auftragsrabatt auf Anfrage /  
prices are valid from 01.01.2024 excl. VAT, subject to change, discounts upon request  
sonst. Konditionen siehe [www.gogatec.com/AGB.pdf](http://www.gogatec.com/AGB.pdf), techn. Änderungen vorbehalten /  
terms & conditions can be found on our website: [www.gogatec.com/AGB.pdf](http://www.gogatec.com/AGB.pdf); error, technical modifications and variations are reserved

# M12 Steckverbinder für geschirmte Leitungen / plugging con. for shielded cables

**Kodierung / coding: A**

**Anschlussart / connection: Schraubanschluss 0,75 mm<sup>2</sup>**

**Temperaturbereich / temperature range: -40°C - +85°C**

**Bemessungsspannung / rated voltage: 250 V**

**Bemessungs-Stoßspannung / rated impulse voltage: 2.500 V**

**Verschmutzungsgrad / pollution degree: 3**

**Überspannungskategorie / overvoltage category: II**

**Isolierstoffgruppe / isolation: II**

**Bemessungsstrom (40°C) / rated current (40°C): 4 A**

**Durchgangswiderstand / contact resistance: < 3 mΩ**

**EMV-Tauglichkeit / EMC: schirmbar / shieldable**

**Schutzart / protection class: IP 67, in verschraubtem Zustand / in locked position**

**Material Kontakt / material contact: CuZn (Messing / brass)**

**Kontaktfläche / contact surface: Au (Gold / gold)**

**Material Kontaktkörper / material contact body: PA**

**Mechanische Lebensdauer / mechanical life span: > 100 Steckzyklen / plugging cycles**

**Bussystem / bus system: auch für Device-Net und CAN geeignet / also suitable for Device-Net and CAN**

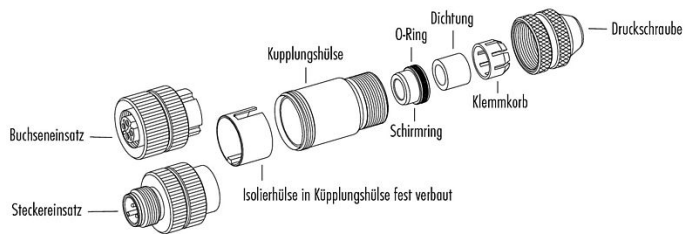

**A-codiert /  
A-coded**

## GOGAPLUG M12 Buchse geschirmt gerade / straight M12 socket shielded

Pole	Klemmbereich mm	ArtNr Schraubklemme	€ /Stk.	ArtNr Käfigzugfeder	€ /Stk.
pole	clamping range	screwing clamp	/pc.	spring clamp	/pc.
4	4 - 6	112F003	22,67	112F013	28,16
	6 - 8	112F004	22,67	112F014	28,16
5	4 - 6	112F005	26,64	112F015	32,16
	6 - 8	112F006	26,64	112F016	32,16
8	6 - 8	112F007	39,54	-	-
	8 - 10	112F008	42,50	-	-

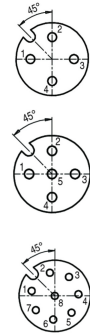
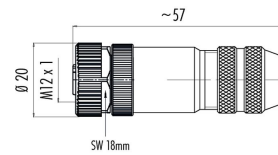

## GOGAPLUG M12 Stift geschirmt gerade / straight M12 plug shielded

Pole	Klemmbereich mm	ArtNr Schraubklemme	€ /Stk.	ArtNr Käfigzugfeder	€ /Stk.
pole	clamping range	screwing clamp	/pc.	spring cage	/pc.
4	4 - 6	112F303	22,17	112F313	27,68
	6 - 8	112F304	22,17	112F314	27,68
5	4 - 6	112F305	26,16	112F315	31,68
	6 - 8	112F306	26,16	112F316	31,68
8	6 - 8	112F307	39,03	-	-
	8 - 10	112F308	41,96	-	-

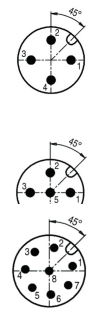
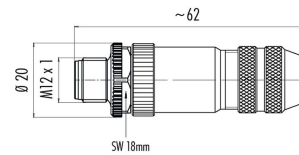

## GOGAPLUG M12 Buchse gerade, Edelstahl / straight M12 socket, stainless steel

Pole	Kabeldurchlass mm	ArtNr Schraubklemme	€ /Stk.
pole	cable outlet	screwing clamp	/pc.
4	3 - 5,5	112V003	82,00
	5,5 - 8,6	112V004	86,00
5	3 - 5,5	112V005	86,00
	5,5 - 8,6	112V006	86,00
8	5,5 - 8,6	112V007	98,90



**Edelstahlgehäuse /  
stainless steel case**

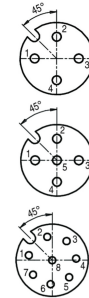
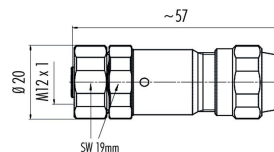

## GOGAPLUG M12 Stift gerade, Edelstahl / straight M12 plug, stainless steel

Pole	Kabeldurchlass mm	ArtNr Schraubklemme	€ /Stk.
pole	cable outlet	screwing clamp	/pc.
4	3 - 5,5	112V303	81,50
	5,5 - 8,6	112V304	81,50
5	3 - 5,5	112V305	85,50
	5,5 - 8,6	112V306	85,50
8	5,5 - 8,6	112V307	98,40



**Edelstahlgehäuse /  
stainless steel case**

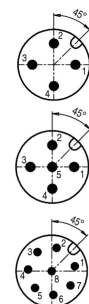
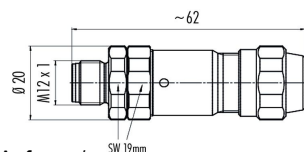

Preise gültig ab 01.01.2024 exkl. MwSt., freibleibend, Auftragsrabatt auf Anfrage /

prices are valid from 01.01.2024 excl. VAT, subject to change, discounts upon request

sonst. Konditionen siehe [www.gogatec.com/AGB.pdf](http://www.gogatec.com/AGB.pdf), techn. Änderungen vorbehalten /

terms & conditions can be found on our website: [www.gogatec.com/AGB.pdf](http://www.gogatec.com/AGB.pdf); error, technical modifications and variations are reserved

## M12 Steckverbinder für geschirmte Leitungen / plugging con. for shielded cables

Kodierung / code: **A**

Anschluss / connection: **Schraubanschluss 0,75 mm<sup>2</sup>**

Temperaturbereich / temperature range: **-40°C - +85°C**

Bemessungsspannung / rated voltage: **250 V**

Bemessungs-Stoßspannung / rated impulse voltage: **2.500 V**

Verschmutzungsgrad / pollution degree: **3**

Überspannungskategorie / overvoltage category: **II**

Isolierstoffgruppe / isolation: **III**

Bemessungsstrom (40°C) / rated current (40°C): **4 A**

Durchgangswiderstand / contact resistance: **< 3 mΩ**

Schutzart / protection class: **IP 67, in verschraubtem Zustand / in locked position**

Material Kontakt / material contact: **CuZn (Messing / brass)**

Kontaktoberfläche / contact surface: **Au (Gold / gold)**

Material Kontaktkörper / material contact body: **PA**

Mechanische Lebensdauer / mechanical life span: **> 50 Steckzyklen / plugging cycles**

Bussystem / bus system: **auch für Device-Net und CAN geeignet / also suitable for Device-Net and CAN**

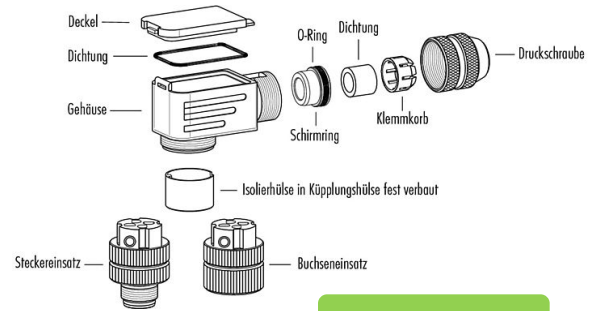

**A-codiert / A-coded**

## GOGAPLUG M12 Buchse geschirmt gewinkelt / shielded angled M12 socket

EMV-Tauglichkeit / EMC: **geschirmt / shielded**

Pole	Klemmbereich mm	ArtNr Schraubklemme	€ /Stk.	ArtNr Käfigzugfeder	€ /Stk.
<i>pole</i>	<i>clamping range</i>	<i>screwing clamp</i>	<i>/pc.</i>	<i>cage spring</i>	<i>/pc.</i>
4	4 - 6	112F100	30,64	112F110	36,16
	6 - 8	112F101	30,64	112F111	36,16
5	4 - 6	112F102	34,64	112F112	40,16
	6 - 8	112F103	34,64	112F113	40,16

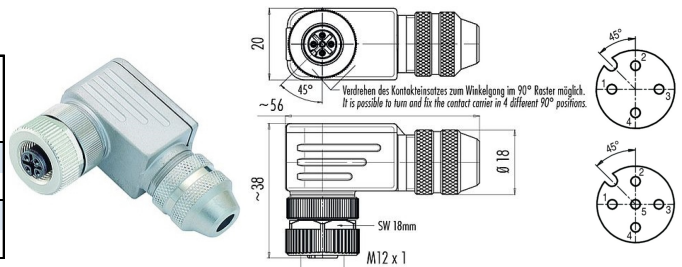

## GOGAPLUG M12 Stift geschirmt gewinkelt / shielded angled M12 plug

EMV-Tauglichkeit / EMC: **schirmbar / shieldable**

Pole	Klemmbereich mm	ArtNr Schraubklemme	€ /Stk.	ArtNr Käfigzugfeder	€ /Stk.
<i>pole</i>	<i>clamping range</i>	<i>screwing clamp</i>	<i>/pc.</i>	<i>cage spring</i>	<i>/pc.</i>
4	4 - 6	112F500	30,16	112F510	35,65
	6 - 8	112F501	30,16	112F511	35,65
5	4 - 6	112F502	34,13	112F512	39,65
	6 - 8	112F503	34,13	112F513	39,65

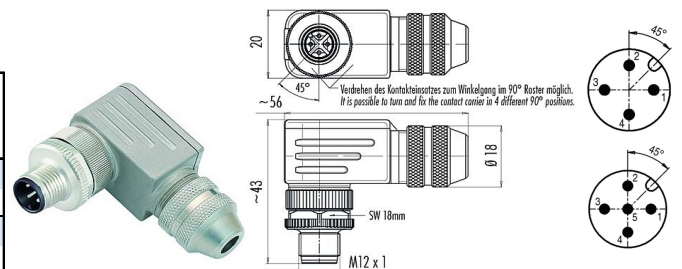

Preise gültig ab 01.01.2024 exkl. MwSt., freibleibend, Auftragsrabatt auf Anfrage /

prices are valid from 01.01.2024 excl. VAT, subject to change, discounts upon request

sonst. Konditionen siehe [www.gogatec.com/AGB.pdf](http://www.gogatec.com/AGB.pdf), techn. Änderungen vorbehalten /

terms & conditions can be found on our website: [www.gogatec.com/AGB.pdf](http://www.gogatec.com/AGB.pdf); error, technical modifications and variations are reserved

# M12 Steckverbinder für Profibus & Interbus / plugging con. for profibus & interbus



VENTILSTECKER  
VALVE PLUGS

**Kodierung / code: B**

**Anschluss / connection: Schraubanschluss 0,75 mm<sup>2</sup>**

**Temperaturbereich / temperature range: -40°C - +85°C**

**Bemessungsspannung / rated voltage: 250 V**

**Bemessungs-Stoßspannung / rated impulse voltage: 2.500 V**

**Verschmutzungsgrad / pollution degree: 3**

**Überspannungskategorie / overvoltage category: II**

**Isolierstoffgruppe / isolation: III**

**Bemessungsstrom (40°C) / rated current (40°C): 4 A**

**Durchgangswiderstand / contact resistance: < 3 mΩ**

**EMV-Tauglichkeit / EMC: schirmbar / shieldable**

**Schutzart / protection class: IP 67, in verschraubtem Zustand / in locked position**

**Material Kontakt / material contact: CuZn (Messing / brass)**

**Kontaktfläche / contact surface: Au (Gold / gold)**

**Material Kontaktkörper / material contact body: PA**

**Mechanische Lebensdauer / mechanical life span: > 100 Steckzyklen / plugging cycles**

**Bussystem / bus system: Profibus, Interbus**

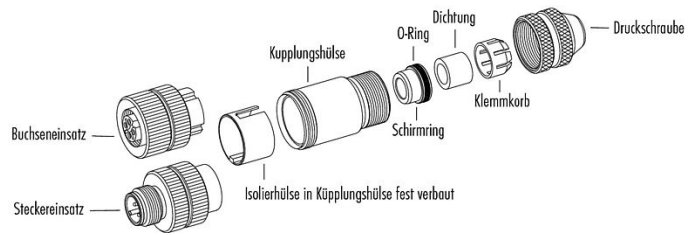

**B-codiert / B-coded**

## GOGAPLUG M12 Buchse geschirmt gerade / shielded straight M12 socket

Pole	Klemmbereich mm	ArtNr Schraubklemme	€ /Stk.	ArtNr Käfigzugfeder	€ /Stk.
pole	clamping range	screwing clamp	/pc.	cage spring	/pc.
4	6 - 8	112F030	26,53	-	-
	6 - 8	112F031	29,74	112F041	36,27
5	6,5 - 8,5	112F032	29,74	112F042	36,27
	8 - 10	112F033	35,40	-	-

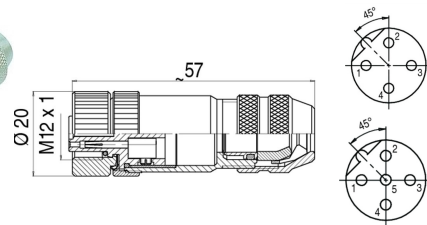

## GOGAPLUG M12 Stift geschirmt gerade / shielded straight M12 plug

Pole	Klemmbereich mm	ArtNr Schraubklemme	€ /Stk.	ArtNr Käfigzugfeder	€ /Stk.
pole	clamping range	screwing clamp	/pc.	cage spring	/pc.
4	6 - 8	112F330	25,99	-	-
	6 - 8	112F331	29,15	112F341	35,40
5	6,5 - 8,5	112F332	29,15	112F342	35,40
	8 - 10	112F333	34,67	-	-

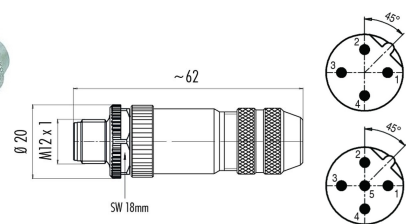

## GOGAPLUG M12 Buchse gerade, Edelstahl / straight M12 socket, stainless steel

Pole	Klemmbereich mm	ArtNr Schraubklemme	€ /Stk.
pole	clamping range	screwing clamp	/pc.
4	5,5 - 8,6	112V030	86,00
5	5,5 - 8,6	112V031	96,30

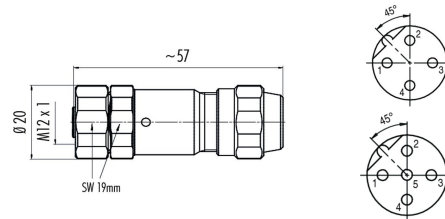

## GOGAPLUG M12 Stift gerade, Edelstahl / straight M12 plug, stainless steel

Pole	Klemmbereich mm	ArtNr Schraubklemme	€ /Stk.
pole	clamping range	screwing clamp	/pc.
4	5,5 - 8,6	112V330	84,30
5	5,5 - 8,6	112V331	94,40

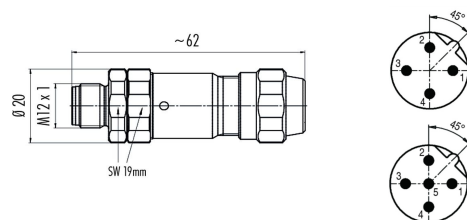

Preise gültig ab 01.01.2024 exkl. MwSt., freibleibend, Auftragsrabatt auf Anfrage /

prices are valid from 01.01.2024 excl. VAT, subject to change, discounts upon request

sonst. Konditionen siehe [www.gogatec.com/AGB.pdf](http://www.gogatec.com/AGB.pdf), techn. Änderungen vorbehalten /

terms & conditions can be found on our website: [www.gogatec.com/AGB.pdf](http://www.gogatec.com/AGB.pdf), error, technical modifications and variations are reserved



# M12 Steckverbinder für Profibus & Interbus / plugging con. for profibus & interbus

**Kodierung / code: B**  
**Anschluss / connection: Schraubanschluss 0,75 mm<sup>2</sup>**  
**Temperaturbereich / temperature range: -40°C - +85°C**  
**Bemessungsspannung / rated voltage: 250 V**  
**Bemessungs-Stoßspannung / rated impulse voltage: 2.500 V**  
**Verschmutzungsgrad / pollution degree: 3**  
**Überspannungskategorie / overvoltage category: II**  
**Isolierstoffgruppe / isolation: II**  
**Bemessungsstrom (40°C) / rated current (40°C): 4 A**  
**Durchgangswiderstand / contact resistance: < 3 mΩ**  
**EMV-Tauglichkeit / EMC: schirmbar / shieldable**  
**Schutzart / protection class: IP 67, in verschraubtem Zustand / in locked position**  
**Material Kontakt / material contact: CuZn (Messing / brass)**  
**Kontaktoberfläche / contact surface: Au (Gold / gold)**  
**Material Kontaktkörper / material contact body: PA**  
**Mechanische Lebensdauer / mechanical life span: > 100 Steckzyklen / plugging cycles**  
**Bussystem / bus system: Profibus, Interbus**

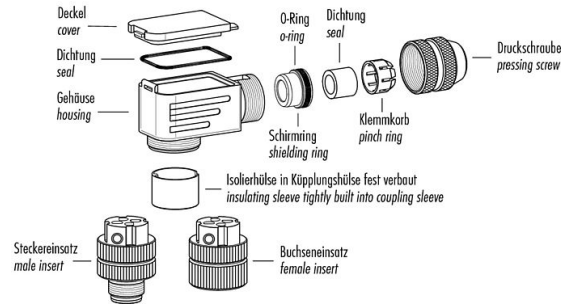

**B-codiert / B-coded**

## GOGAPLUG M12 Buchse geschirmt gewinkelt / angled M12 socket shielded

Pole	Klemmbereich mm	ArtNr Schraubklemme	€ /Stk.	ArtNr Käfigzugfeder	€ /Stk.
pole	clamping range	screwing clamp	/pc.	cage spring	/pc.
4	6 - 8	112F130	31,82	-	-
5	6 - 8	112F131	35,71	112F141	43,54
	6,5 - 8,5	112F132	36,22	112F142	43,54

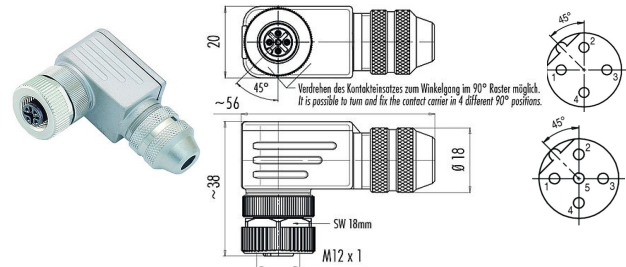

## GOGAPLUG M12 Stift geschirmt gewinkelt / angled M12 plug shielded

Pole	Klemmbereich mm	ArtNr Schraubklemme	€ /Stk.	ArtNr Käfigzugfeder	€ /Stk.
pole	clamping range	screwing clamp	/pc.	cage spring	/pc.
4	6 - 8	112F530	31,20	-	-
5	6 - 8	112F531	34,98	112F541	43,31
	6,5 - 8,5	112F532	34,98	112F542	43,31

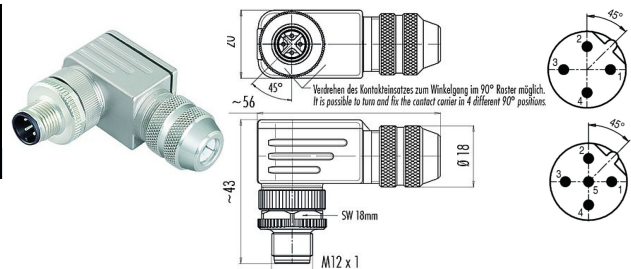

Preise gültig ab 01.01.2024 exkl. MwSt., freibleibend, Auftragsrabatt auf Anfrage /  
 prices are valid from 01.01.2024 excl. VAT, subject to change, discounts upon request  
 sonst. Konditionen siehe [www.gogatec.com/AGB.pdf](http://www.gogatec.com/AGB.pdf), techn. Änderungen vorbehalten /  
 terms & conditions can be found on our website: [www.gogatec.com/AGB.pdf](http://www.gogatec.com/AGB.pdf); error, technical modifications and variations are reserved

# M12 Steckverbinder für Ethernet, CAT.5e / plugging con. for ethernet, CAT.5e



VENTILSTECKER  
VALVE PLUGS

**Kodierung / code: D**

**Anschluss / connection: Schraubanschluss 0,75 mm<sup>2</sup>**

**Temperaturbereich / temperature range: -40°C - +85°C**

**Bemessungsspannung / rated voltage: 250 V**

**Bemessungs-Stoßspannung / rated impulse voltage: 2.500 V**

**Verschmutzungsgrad / pollution degree: 3**

**Überspannungskategorie / overvoltage category: II**

**Isolierstoffgruppe / isolation: III**

**Bemessungsstrom (40°C) / rated current (40°C): 4 A**

**Durchgangswiderstand / contact resistance: < 3 mΩ**

**EMV-Tauglichkeit / EMC: geschirmt / shielded**

**Schutzart / protection class: IP 67, in verschraubtem Zustand / in locked position**

**Material Kontakt / material contact: CuZn (Messing / brass)**

**Kontaktoberfläche / contact surface: Au (Gold / gold)**

**Material Kontaktkörper / material contact body: PA**

**Mechanische Lebensdauer / mechanical life span: > 100 Steckzyklen / plugging cycles**

**Bussystem / bus system: Ethernet, CAT.5e**

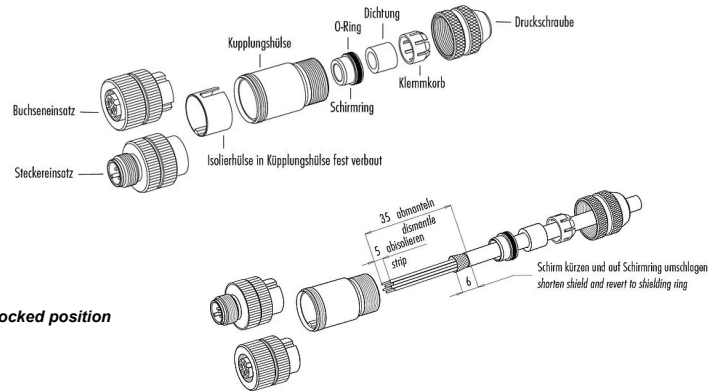

**D-codiert / D-coded**

## GOGAPLUG M12 Buchse geschirmt gerade / straight M12 socket shielded

Pole	Klemmbereich mm	ArtNr Schraubklemme	€ /Stk.
pole	clamping range	screwing clamp	/pc.
4	6 - 8	112F060	25,52

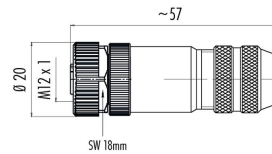

## GOGAPLUG M12 Stift geschirmt gerade / straight M12 plug shielded

Pole	Klemmbereich mm	ArtNr Schraubklemme	€ /Stk.
pole	clamping range	screwing clamp	/pc.
4	6 - 8	112F360	28,36

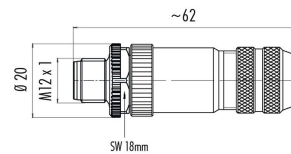

## GOGAPLUG M12 Stift gerade, Edelstahl / straight M12 plug, stainless steel

Pole	Klemmbereich mm	ArtNr Schraubklemme	€ /Stk.
pole	clamping range	screwing clamp	/pc.
4	5,5 - 8,6	112V360	103,70

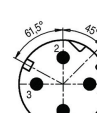
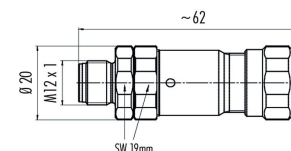

**Im Edelstahlgehäuse /  
in stainless steel case**

Preise gültig ab 01.01.2024 exkl. MwSt., freibleibend, Auftragsrabatt auf Anfrage /

prices are valid from 01.01.2024 excl. VAT, subject to change, discounts upon request

sonst. Konditionen siehe [www.gogatec.com/AGB.pdf](http://www.gogatec.com/AGB.pdf), techn. Änderungen vorbehalten /

terms & conditions can be found on our website: [www.gogatec.com/AGB.pdf](http://www.gogatec.com/AGB.pdf); error, technical modifications and variations are reserved

## M12 Steckverbinder für Ethernet, CAT.5e / plugging con. for ethernet, CAT.5e

**Kodierung / coding:** D

**Anschluss / connection:** Schraubanschluss 0,75 mm<sup>2</sup>

**Temperaturbereich / temperature range:** -40°C - +85°C

**Bemessungsspannung / rated voltage:** 250 V

**Bemessungs-Stoßspannung / rated impulse voltage:** 2.500 V

**Verschmutzungsgrad / pollution degree:** 3

**Überspannungskategorie / overvoltage category:** II

**Isolierstoffgruppe / isolation:** III

**Bemessungsstrom (40°C) / rated current (40°C):** 4 A

**Durchgangswiderstand / contact resistance:** < 3 mΩ

**EMV-Tauglichkeit / EMC:** geschirmt / shielded

**Schutzart / protection class:** IP 67, in verschraubtem Zustand / in locked position

**Material Kontakt / material contact:** CuZn (Messing / brass)

**Kontaktoberfläche / contact surface:** Au (Gold / gold)

**Material Kontaktkörper / material contact body:** PA

**Mechanische Lebensdauer / mechanical life span:** > 100 Steckzyklen / plugging cycles

**Bussystem / bus system:** Ethernet

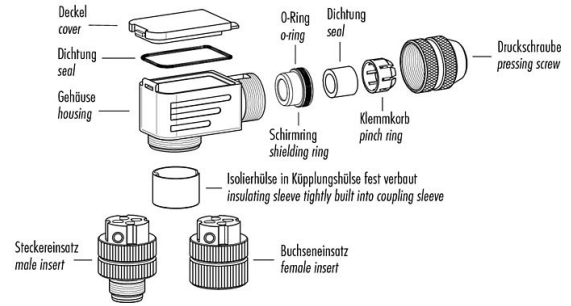

D-codiert / D-coded

### GOGAPLUG M12 Buchse geschirmt gewinkelt / angled M12 socket shielded

Pole	Klemmbereich mm	ArtNr Schraubklemme	€ /Stk.
pole	clamping range	screwing clamp	/pc.
4	5,5 - 8,6	112F160	33,12

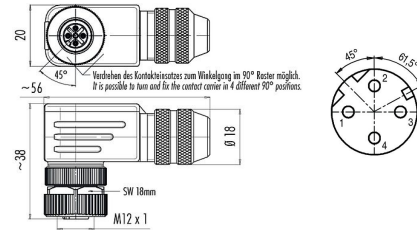

### GOGAPLUG M12 Stift geschirmt gewinkelt / angled M12 plug shielded

Pole	Klemmbereich mm	ArtNr Schraubklemme	€ /Stk.
pole	clamping range	screwing clamp	/pc.
4	6 - 8	112F560	36,84

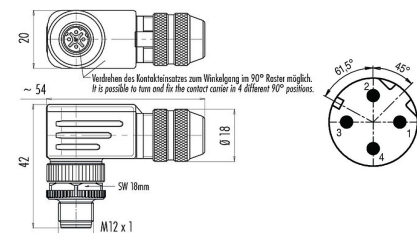

Preise gültig ab 01.01.2024 exkl. MwSt., freibleibend, Auftragsrabatt auf Anfrage /  
 prices are valid from 01.01.2024 excl. VAT, subject to change, discounts upon request  
 sonst. Konditionen siehe [www.gogatec.com/AGB.pdf](http://www.gogatec.com/AGB.pdf), techn. Änderungen vorbehalten /  
 terms & conditions can be found on our website: [www.gogatec.com/AGB.pdf](http://www.gogatec.com/AGB.pdf); error, technical modifications and variations are reserved