

Preisgünstige Kleinkabelschuhe isoliert / insulated mini cable lugs



VERBINDUNGSTECHNIK
CABLE ENDTERMINATIONS

Material / material: E-Cu, gal. Sn

Material Isolation / insulation: PVC / vinyl

Temperaturbereich / temperature range: -10°C - +75°C

Zulassung / approval: teilweise / partly UL listed

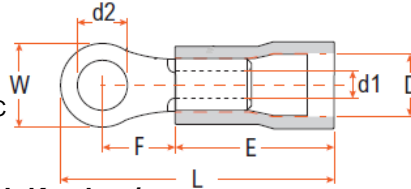

PVC – Isolierung /
insulation

Passende Werkzeuge siehe GOGATOOL Katalog / for appropriate tools please see GOGATOOL catalog

Rohr/Hals nicht gelötet / tube not brazed

GOGAPIN KKS2-RK Quetschkabelschuh-Ring isoliert / insulated solderless cable lug ring

FC	Typ type	Bereich mm ² range	Loch für hole size	Abmessung mm						VPE Stk. PU	ArtNr	€/100 Stk. /100 pcs.
				d1	d2	W	L	E	F			
RT	KKS2-RK-1,5-M3	0,5 - 1,5	M3	1,7	3,3	5,5	17,5	10,0	4,8	100	121110001503	4,03
	KKS2-RK-1,5-M3,5		M3,5	1,7	3,8	5,5	17,5	10,0	4,8	100	1211100015035	4,03
	KKS2-RK-1,5-M4		M4	1,7	4,4	6,6	19,4	10,0	6,3	100	121110001504	4,26
	KKS2-RK-1,5-M5		M5	1,7	5,4	8,0	20,8	10,0	7,0	100	121110001505	4,26
	KKS2-RK-1,5-M6		M6	1,7	6,5	11,6	26,7	10,0	11,0	100	121110001506	4,80
	KKS2-RK-1,5-M8		M8	1,7	8,5	11,6	26,7	10,0	11,0	100	121110001508	6,41
	KKS2-RK-1,5-M10		M10	1,7	10,5	13,6	30,5	10,0	13,9	100	121110001510	8,36
KKS2-RK-1,5-M12	M12	1,7	13,0	18,0	35,4	10,0	15,2	100	121110001512	13,50		
BL	KKS2-RK-2,5-M3	1,5 - 2,5	M3	2,3	3,3	6,6	17,8	10,0	4,7	100	121110002503	4,47
	KKS2-RK-2,5-M3,5		M3,5	2,3	3,8	6,6	18,8	10,0	4,7	100	1211100025035	5,15
	KKS2-RK-2,5-M4		M4	2,3	4,4	6,6	21,8	10,0	6,3	100	121110002504	4,64
	KKS2-RK-2,5-M5		M5	2,3	5,4	8,5	21,8	10,0	7,8	100	121110002505	5,15
	KKS2-RK-2,5-M6		M6	2,3	6,4	12,0	26,8	10,0	11,0	100	121110002506	6,47
	KKS2-RK-2,5-M8		M8	2,3	8,4	12,0	26,8	10,0	11,0	100	121110002508	6,88
	KKS2-RK-2,5-M10		M10	2,3	10,5	13,6	30,5	10,0	13,9	100	121110002510	10,96
KKS2-RK-2,5-M12	M12	2,3	13,0	19,2	35,0	10,0	15,2	100	121110002512	19,63		
GE	KKS2-RK-6-M3,5	4 - 6	M3	3,4	3,7	7,2	22,7	13,0	6,1	100	1211100060035	9,93
	KKS2-RK-6-M4		M4	3,4	4,4	7,2	23,2	13,0	6,1	100	121110006004	8,30
	KKS2-RK-6-M5		M5	3,4	5,4	9,5	27,3	13,0	8,3	100	121110006005	8,63
	KKS2-RK-6-M6		M6	3,4	6,4	12,0	29,5	13,0	11,2	100	121110006006	10,52
	KKS2-RK-6-M8		M8	3,4	8,5	15,0	34,5	13,0	13,5	100	121110006008	13,16
	KKS2-RK-6-M10		M10	3,4	10,6	15,0	34,5	13,0	13,5	100	121110006010	12,45
KKS2-RK-6-M12	M12	3,4	13,0	19,2	39,1	13,0	16,0	100	121110006012	15,31		

PVC

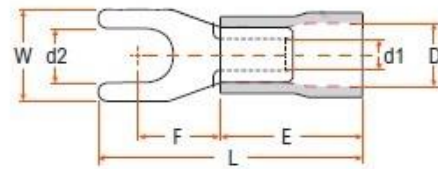

GOGAPIN KKS2-GK Quetschkabelschuh-Gabel isoliert / insulated solderless cable lug fork

FC	Typ type	Bereich mm ² range	Loch für hole size	Abmessungen mm						VPE Stk. PU	ArtNr	€/100 Stk. /100 pcs.	
				D	d1	d2	W	L	E				F
RT	KKS2-GK-1,5-M3	0,5 - 1,5	M3	4,3	1,7	3,3	5,7	21,0	10,0	6,5	100	121120001503	4,14
	KKS2-GK-1,5-M3,5		M3,5	4,3	1,7	3,8	5,7	21,0	10,0	6,5	100	1211200015035	4,14
	KKS2-GK-1,5-M4		M4	4,3	1,7	4,4	6,4	21,0	10,0	6,5	100	121120001504	4,14
	KKS2-GK-1,5-M5		M5	4,3	1,7	5,4	8,1	21,0	10,0	6,5	100	121120001505	4,14
	KKS2-GK-1,5-M6		M6	4,3	1,7	6,6	9,5	21,0	10,0	6,5	100	121120001506	5,17
BL	KKS2-GK-2,5-M3	1,5 - 2,5	M3	4,3	2,3	3,3	5,7	21,0	10,0	6,5	100	121120002503	4,28
	KKS2-GK-2,5-M3,5		M3,5	4,3	2,3	3,8	5,7	21,0	10,0	6,5	100	1211200025035	5,48
	KKS2-GK-2,5-M4		M4	4,3	2,3	4,4	6,4	21,0	10,0	6,5	100	121120002504	5,54
	KKS2-GK-2,5-M5		M5	4,8	2,3	5,4	8,1	21,0	10,0	6,5	100	121120002505	4,76
KKS2-GK-2,5-M6	M6	4,8	2,3	6,6	9,3	21,0	10,0	6,5	100	121120002506	4,64		
GE	KKS2-GK-6-M3,5	4-6	M3	6,7	3,4	3,8	8,3	25,5	13,0	7,0	100	1211200060035	8,76
	KKS2-GK-6-M4		M4	6,7	3,4	4,4	8,3	25,5	13,0	7,0	100	121120006004	7,95
	KKS2-GK-6-M5		M5	6,7	3,4	5,4	9,0	25,5	13,0	7,0	100	121120006005	7,95
	KKS2-GK-6-M6		M6	6,7	3,4	6,6	9,0	25,5	13,0	7,0	100	121120006006	8,49
KKS2-GK-6-M8	M8	6,7	3,4	8,5	14,0	30,5	13,0	11,5	100	121120006008	14,03		

PVC



Preise gültig ab 01.01.2024 exkl. MwSt., freibleibend, Auftragsrabatt auf Anfrage /

prices are valid from 01.01.2024 excl. VAT, subject to change, discounts upon request

sonst. Konditionen siehe www.gogatec.com/AGB.pdf, techn. Änderungen vorbehalten /

terms & conditions can be found on our website: www.gogatec.com/AGB.pdf; error, technical modifications and variations are reserved



Material / *material*: E-Cu, gal. Sn
 Material Isolation / *insulation*: PVC / *vinyl*
 Temperaturbereich / *temperature range*: -10°C - +75°C
 Zulassung / *approval*: teilweise / *partly* UL listed

PVC – Isolierung /
insulation

Passende Werkzeuge siehe GOGATOOL Katalog / *for appropriate tools please see GOGATOOL catalog*
 Rohr/Hals nicht gelötet / *tube not brazed*

GOGAPIN KKS2-SV Stoßverbinder isoliert / *insulated butt connectors*

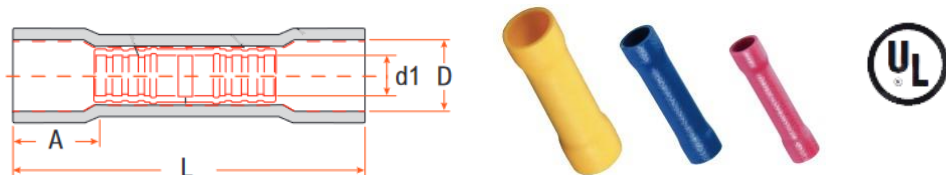

FC	Typ <i>type</i>	Bereich <i>mm² range</i>	Abmessung mm				VPE <i>Stk. PU</i>	ArtNr	€/100 Stk. <i>/100 pcs.</i>
RT	KKS2-SV-1,5	0,5 - 1,5	5,8	4,3	1,8	24,5	100	1211800015	4,83
BL	KKS2-SV-2,5	1,5 - 2,5	5,8	4,8	2,4	24,5	100	1211800025	5,14
GE	KKS2-SV-6	4 - 6	6,2	6,7	3,5	27,0	100	1211800060	9,16

PVC

GOGAPIN KKS2-SK Stiftkabelschuh isoliert / *insulated pin cable lug*

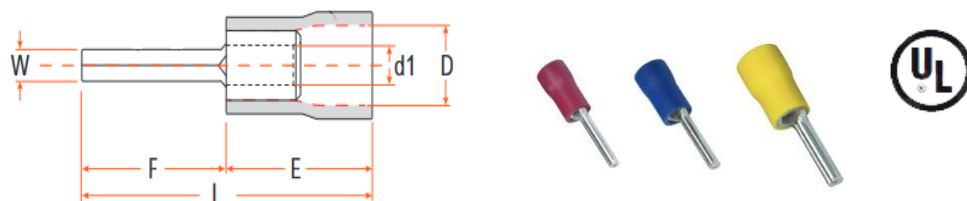

FC	Typ <i>type</i>	Bereich <i>mm² range</i>	Stift <i>mm pin</i>	Abmessung mm					VPE <i>Stk. PU</i>	ArtNr	€/100 Stk. <i>/100 pcs.</i>	
RT	KKS2-SK-1,5-1912	0,5 - 1,5	1,9x12	4,3	1,7	1,9	21,8	10,0	12,0	100	12113000151912	4,87
BL	KKS2-SK-2,5-1912	1,5 - 2,5	1,9x12	4,8	2,3	1,9	21,8	10,0	12,0	100	12113000251912	5,07
GE	KKS2-SK-6-2914	4 - 6	2,9x14	6,7	3,4	2,8	26,0	13,0	13,0	100	12113000602914	10,03

PVC

GOGAPIN KKS2-FSK Flachstiftkabelschuh isoliert / *insulated pin cable lug*

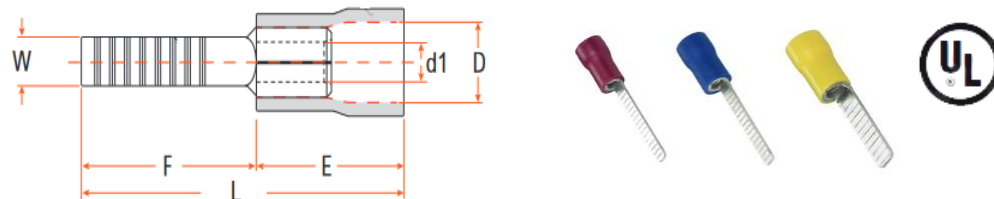

FC	Typ <i>type</i>	Bereich <i>mm² range</i>	Stift <i>mm pin</i>	Abmessung mm					VPE <i>Stk. PU</i>	ArtNr	€/100 Stk. <i>/100 pcs.</i>	
RT	KKS2-FSK-1,5-2310	0,5 - 1,5	2,3x10	4,3	1,7	2,3	20,0	10,0	10,0	100	12113500152310	7,60
	KKS2-FSK-1,5-2318		2,3x18	4,3	1,7	2,2	28,0	10,0	18,0	100	12113500152318	9,52
BL	KKS2-FSK-2,5-2809	1,5 - 2,5	2,8x9	4,8	2,3	2,8	19,0	10,0	9,0	100	12113500252809	4,88
	KKS2-FSK-2,5-2318		2,3x18	4,8	2,3	2,2	28,0	10,0	18,0	100	12113500252318	10,65
GE	KKS2-FSK-6-2810	4 - 6	2,8x10	6,7	3,4	2,8	23,0	13,0	10,0	100	12113500602810	9,14

PVC

Preise gültig ab 01.01.2024 exkl. MwSt., freibleibend, Auftragsrabatt auf Anfrage /
 prices are valid from 01.01.2024 excl. VAT, subject to change, discounts upon request
 sonst. Konditionen siehe www.gogatec.com/AGB.pdf, techn. Änderungen vorbehalten /
 terms & conditions can be found on our website: www.gogatec.com/AGB.pdf; error, technical modifications and variations are reserved

Passende Werkzeuge siehe GOGATOOL Katalog / for appropriate tools please see GOGATOOL catalog

GOGAPIN KKS-RK Quetschkabelschuh-Ring isoliert / insulated solderless cable lug ring

Material / material: E-Cu, gal. Sn
 Material Isolation / insulation: Polyamid 6.6
 Temperaturbereich / temperature range: -60°C - +105°C
 Zulassung / approval: teilweise / partly UL listed
 Normen / standards: DIN 46237

**Polyamid – Isolierung /
polyamide insulation**

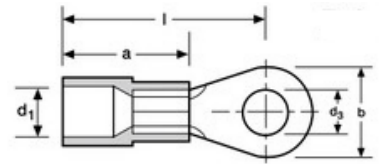

DIN PA einfache Einführung, Rohr gelötet / easy entry, brazed

FC	Typ type	Bereich mm ² range	Loch für hole size	d3	Abmessung mm dimensions mm					VPE Stk. PU	ArtNr	€/100 Stk. /100 pcs.
GE	KKS-RK-0,5-M2	0,1 - 0,5	M2,5	2,2	5,0	3,2	15,0	10,0	0,5	100	121310000502	28,39
	KKS-RK-0,5-M3		M3	3,2	5,0	3,2	15,0	10,0	0,5	100	121310000503	12,53
	KKS-RK-0,5-M3,5		M3,5	3,7	6,0	3,2	15,0	10,0	0,5	100	1213100005035	a.A.
	KKS-RK-0,5-M4		M4	4,3	6,0	3,2	17,0	10,0	0,5	100	121310000504	11,53
	KKS-RK-0,5-M5		M5	5,3	8,0	3,2	17,0	10,0	0,5	100	121310000505	12,94
RT	KKS-RK-1,5-M2,5	0,5 - 1,5	M2,5	2,7	6,0	4,0	16,0	10,0	0,8	100	1213100015025	8,17
	KKS-RK-1,5-M3		M3	3,2	6,0	4,0	16,0	10,0	0,8	100	121310001503	6,22
	KKS-RK-1,5-M3,5		M3,5	3,7	6,0	4,0	16,0	10,0	0,8	100	1213100015035	7,14
	KKS-RK-1,5-M4		M4	4,3	8,0	4,0	17,0	10,0	0,8	100	121310001504	6,83
	KKS-RK-1,5-M5		M5	5,3	10,0	4,0	18,0	10,0	0,8	100	121310001505	7,35
	KKS-RK-1,5-M6		M6	6,5	11,0	4,0	21,0	10,0	0,8	100	121310001506	7,23
	KKS-RK-1,5-M8		M8	8,4	11,6	4,0	22,0	10,0	0,8	100	121310001508	9,61
KKS-RK-1,5-M10	M10	10,5	13,7	4,0	22,0	10,0	0,8	100	121310001510	15,43		
BL	KKS-RK-2,5-M3	1,5 - 2,5	M3	3,2	6,0	4,5	17,0	11,0	0,8	100	121310002503	6,64
	KKS-RK-2,5-M3,5		M3,5	3,7	6,0	4,5	17,0	11,0	0,8	100	1213100025035	8,61
	KKS-RK-2,5-M4		M4	4,3	8,0	4,5	18,0	11,0	0,8	100	121310002504	7,07
	KKS-RK-2,5-M5		M5	5,3	10,0	4,5	20,0	11,0	0,8	100	121310002505	7,69
	KKS-RK-2,5-M6		M6	6,5	11,0	4,5	22,0	11,0	0,8	100	121310002506	7,94
	KKS-RK-2,5-M8		M8	8,4	12,0	4,5	23,0	11,0	0,8	100	121310002508	9,65
	KKS-RK-2,5-M10		M10	10,5	13,7	4,5	25,0	11,0	0,8	100	121310002510	12,87
KKS-RK-2,5-M12	M12	13,0	19,0	4,5	25,0	11,0	0,8	100	121310002512	22,51		
GE	KKS-RK-6-M4	4 - 6	M4	4,3	8,0	6,6	20,0	14,0	1,0	100	121310006004	12,92
	KKS-RK-6-M5		M5	5,3	10,0	6,6	21,0	14,0	1,0	100	121310006005	11,47
	KKS-RK-6-M6		M6	6,5	11,0	6,6	22,0	14,0	1,0	100	121310006006	14,10
	KKS-RK-6-M8		M8	8,4	14,0	6,6	25,0	14,0	1,0	100	121310006008	14,14
	KKS-RK-6-M10		M10	10,5	18,0	6,6	27,0	14,0	1,0	100	121310006010	16,16
	KKS-RK-6-M12		M12	13,0	19,0	6,6	32,0	14,0	1,0	100	121310006012	16,33
	KKS-RK-6-M14		M14	15,0	19,0	6,6	32,0	14,0	1,0	100	121310006014	64,70



a. A. = auf Anfrage / upon request

GOGAPIN KKS-SK Stiftkabelschuh isoliert / insulated pin cable lug

Material / material: E-Cu, gal. Sn
 Material Isolation / insulation: Polyamid 6.6
 Temperaturbereich / temperature range: -60°C - +105°C
 Zulassung / approval: teilweise / partly UL listed
 Normen / standards: DIN 46231 und ähnlich / and similar

**Polyamid – Isolierung /
polyamide insulation**

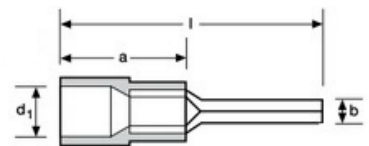

FC	Typ type	Bereich mm ² range	Abmessung mm dimensions mm			VPE Stk. PU	ArtNr	€/100 Stk. /100 pcs.		
RT	KKS-SK-1,5-1909	0,5 - 1,5	2,0	4,1	19,0	10,0	0,8	100	12133000151909	8,33
	KKS-SK-1,5-1912		2,0	4,1	22,0	10,0	0,8	100	12133000151912	8,77
	KKS-SK-1,5-1920		1,9	4,1	27,5	10,0	0,8	100	12133000151920	13,93
BL	KKS-SK-2,5-1909	1,5 - 2,5	2,0	4,5	20,0	11,0	0,8	100	12133000251909	6,87
	KKS-SK-2,5-1911		2,0	4,5	23,5	11,0	0,8	100	12133000251911	6,12
	KKS-SK-2,5-1916		1,9	4,5	26,0	10,0	0,8	100	12133000251916	19,04
	KKS-SK-2,5-1920		1,9	4,5	32,0	10,0	0,8	100	12133000251920	20,15
GE	KKS-SK-6-2713	4 - 6	2,7	6,6	26,0	12,0	1,0	100	12133000602713	9,51



Preise gültig ab 01.01.2024 exkl. MwSt., freibleibend, Auftragsrabatt auf Anfrage /

prices are valid from 01.01.2024 excl. VAT, subject to change, discounts upon request

sonst. Konditionen siehe www.gogatec.com/AGB.pdf, techn. Änderungen vorbehalten /

terms & conditions can be found on our website: www.gogatec.com/AGB.pdf; error, technical modifications and variations are reserved

Passende Werkzeuge siehe GOGATOOL Katalog / for appropriate tools please see GOGATOOL catalog

GOGAPIN KKS-GK Quetschkabelschuh-Gabel isoliert / insulated solderless cable lug fork

Material / material: E-Cu, gal. Sn
 Material Isolation / insulation: Polyamid 6.6
 Temperaturbereich / temperature range: -60°C - +105°C
 Zulassung / approval: teilweise / partly UL listed
 Normen / standards: DIN 46237

Polyamid – Isolierung /
polyamide insulation

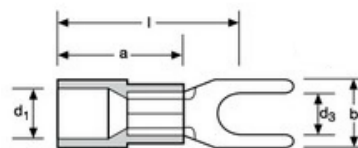

DIN PA einfache Einführung, Rohr gelötet / easy entry, brazed

FC	Typ type	Bereich mm ² range	Gabel für fork size	Abmessung mm dimensions mm						VPE Stk. PU	ArtNr	€ /100 Stk. /100 pcs.
				d3	b	d1	l	a	s			
RT	KKS-GK-1,5-M3	0,5- 1,5	M3	3,2	5,7	4,1	17,7	10,0	0,8	100	121320001503	6,49
	KKS-GK-1,5-M3,5		M3,5	3,7	6,0	4,1	17,7	10,0	0,8		1213200015035	7,20
	KKS-GK-1,5-M4		M4	4,3	7,2	4,1	17,7	10,0	0,8		121320001504	7,41
	KKS-GK-1,5-M5		M5	5,3	8,0	4,1	17,0	10,0	0,8		121320001505	5,77
	KKS-GK-1,5-M6		M6	6,4	10,7	4,1	18,5	10,0	0,8		121320001506	7,18
	KKS-GK-1,5-M8		M8	8,4	13,5	4,1	21,5	10,0	0,8		121320001508	15,19
	KKS-GK-1,5-M10		M10	10,5	15,0	4,1	22,0	10,0	0,8		121320001510	12,13
BL	KKS-GK-2,5-M3	1,5- 2,5	M3	3,2	5,7	4,5	17,5	11,0	0,8	100	121320002503	7,79
	KKS-GK-2,5-M3,5		M3,5	3,7	6,2	4,5	17,5	11,0	0,8		1213200025035	7,39
	KKS-GK-2,5-M4		M4	4,3	7,2	4,5	17,5	11,0	0,8		121320002504	6,90
	KKS-GK-2,5-M5		M5	5,3	8,0	4,5	17,5	11,0	0,8		121320002505	6,33
	KKS-GK-2,5-M6		M6	6,4	10,7	4,5	18,6	11,0	0,8		121320002506	7,52
	KKS-GK-2,5-M8		M8	8,4	13,5	4,5	23,0	10,0	0,8		121320002508	15,37
GE	KKS-GK-6-M3,5	4-6	M3,5	3,7	8,1	6,6	21,1	14,0	1,0	100	1213200060035	13,16
	KKS-GK-6-M4		M4	4,3	8,2	6,6	21,5	14,0	1,0		121320006004	12,08
	KKS-GK-6-M5		M5	5,3	9,0	6,6	22,0	14,0	1,0		121320006005	10,83
	KKS-GK-6-M6		M6	6,4	12,0	6,6	23,5	14,0	1,0		121320006006	13,57
	KKS-GK-6-M8		M8	8,4	13,5	6,6	25,0	14,0	1,0		121320006008	17,54
	KKS-GK-6-M10		M10	10,5	18,0	6,4	27,0	12,0	1,0		121320006010	25,89



GOGAPIN KKS-SVR Reduzierstoßverbinder isoliert / insulated reduction butt connectors

Material / material: Messing, gal. verzinkt / brass tin-plated
 Material Isolation / insulation: PVC
 Temperaturbereich / temperature range: -10°C - +75°C
 Zulassung / approval: teilweise / partly UL listed

PVC – Isolierung /
insulation

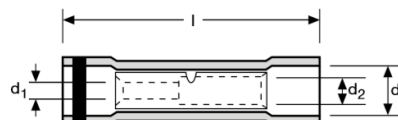

FC	Typ type	Bereich von mm ² from range	Bereich auf mm ² to range	Abmessung mm dimensions mm				VPE Stk. PU	ArtNr	€ /100 Stk. /100 pcs.
				l1	d1	d2	d3			
B R	KKS-SVR-2,5-1,5	1,5 - 2,5	0,5-1,5	24,5	4,5	2,3	1,7	100	12138100250015	227,00
G R	KKS-SVR-6-1,5	4-6	0,5-1,5	31,0	6,3	3,4	1,7	100	12138100600015	203,00
G B	KKS-SVR-6-2,5	4-6	1,5-2,5	31,0	6,3	3,4	1,7	100	12138100600025	213,00

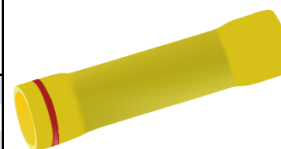

Preise gültig ab 01.01.2024 exkl. MwSt., freibleibend, Auftragsrabatt auf Anfrage /
 prices are valid from 01.01.2024 excl. VAT, subject to change, discounts upon request
 sonst. Konditionen siehe www.gogatec.com/AGB.pdf, techn. Änderungen vorbehalten /
 terms & conditions can be found on our website: www.gogatec.com/AGB.pdf; error, technical modifications and variations are reserved

Passende Werkzeuge siehe GOGATOOL Katalog / for appropriate tools please see GOGATOOL catalog

GOGAPIN KKS-FH Flachsteckhülse isoliert / insulated flat connector sleeve

Material / material: Messing, gal. verzinkt / brass tin-plated
Material Isolation / insulation: PVC mit Isolationscrimp / vinyl with copper sleeve
Temperaturbereich / temperature range: -10°C - +75°C
Zulassung / approval: teilweise / partly UL listed
Normen / standards: DIN 46245

PVC

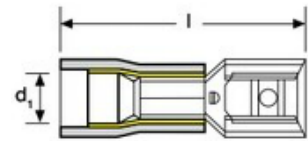

FC	Typ type	Bereich mm ² range	Steckgröße mm tab size	Abmessung mm dimensions mm				VPE Stk. PU	ArtNr	€/100 Stk. /100 pcs.
GE	KKS-FH-0,5-2805	0,2 - 0,5	2,8 - 0,5	16,0	3,2	0,25	100	12135000052805	10,40	
	KKS-FH-0,5-2808		2,8 - 0,8	16,0	3,2	0,25	100	12135000052808	12,13	
RT	KKS-FH-1,5-2805	0,5 - 1,5	2,8 - 0,5	19,0	4,1	0,25	100	12135000152805	4,80	
	KKS-FH-1,5-2808		2,8 - 0,8	19,0	4,1	0,25	100	12135000152808	5,37	
	KKS-FH-1,5-4805		4,8 - 0,5	19,5	4,1	0,40	100	12135000154805	5,95	
	KKS-FH-1,5-4808		4,8 - 0,8	19,5	4,1	0,40	100	12135000154808	5,95	
	KKS-FH-1,5-6308		6,3 - 0,8	21,5	4,1	0,40	100	12135000156308	5,98	
BL	KKS-FH-2,5-2805	1,5 - 2,5	2,8 - 0,5	19,5	5,0	0,25	100	12135000252805	7,08	
	KKS-FH-2,5-2808		2,8 - 0,8	19,5	5,0	0,25	100	12135000252808	7,14	
	KKS-FH-2,5-4805		4,8 - 0,5	20,0	5,0	0,40	100	12135000254805	6,06	
	KKS-FH-2,5-4808		4,8 - 0,8	20,0	5,0	0,40	100	12135000254808	6,06	
	KKS-FH-2,5-6308		6,3 - 0,8	21,5	5,0	0,40	100	12135000256308	5,98	
	KKS-FH-2,5-8508		8,0 - 0,8	24,5	5,0	0,40	100	12135000258005	13,93	
GE	KKS-FH-6-4808	4-6	4,8 - 0,8	23,0	6,6	0,40	100	12135000604808	9,23	
	KKS-FH-6-6308		6,3 - 0,8	24,0	6,6	0,40	100	12135000606308	9,89	
	KKS-FH-6-9511		9,5 - 1,2	28,6	6,6	0,50	100	12135000609511	14,31	

GOGAPIN KKS-FHVI Flachsteckhülse vollisoliert / fully insulated flat connector sleeve

Material / material: Messing, gal. verzinkt / brass tin-plated
Material Isolation / insulation: PVC mit Isolationscrimp / vinyl with copper sleeve
Temperaturbereich / temperature range: -10°C - +75°C
Zulassung / approval: teilweise / partly UL listed

PVC

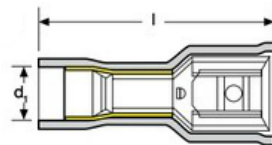

FC	Typ type	Bereich mm ² range	Steckgröße mm tab size	Abmessung mm dimensions mm				VPE Stk. PU	ArtNr	€/100 Stk. /100 pcs.
RT	KKS-FHVI-1,5-2805	0,5 - 1,5	2,8 - 0,5	20,5	4,1	0,25	100	12135100152805	8,18	
	KKS-FHVI-1,5-2808		2,8 - 0,8	20,5	4,1	0,25	100	12135100152808	7,70	
	KKS-FHVI-1,5-4805		4,8 - 0,5	20,5	4,1	0,40	100	12135100154805	8,09	
	KKS-FHVI-1,5-4808		4,8 - 0,8	20,5	4,1	0,40	100	12135100154808	7,70	
	KKS-FHVI-1,5-6308		6,3 - 0,8	22,0	4,1	0,40	100	12135100156308	7,38	
BL	KKS-FHVI-2,5-2805	1,5 - 2,5	2,8 - 0,5	20,5	4,9	0,25	100	12135100252805	9,73	
	KKS-FHVI-2,5-2808		2,8 - 0,8	20,5	4,9	0,25	100	12135100252808	13,73	
	KKS-FHVI-2,5-4805		4,8 - 0,5	21,5	4,9	0,40	100	12135100254805	6,98	
	KKS-FHVI-2,5-4808		4,8 - 0,8	21,5	4,9	0,40	100	12135100254808	6,98	
GE	KKS-FHVI-2,5-6308	4 - 6	6,3 - 0,8	22,5	4,9	0,40	100	12135100256308	6,97	
	KKS-FHVI-6-4805		4,8 - 0,5	22,0	6,7	0,40	100	12135100604805	11,74	
	KKS-FHVI-6-4808		4,8 - 0,8	22,0	6,7	0,40	100	12135100604808	12,05	
	KKS-FHVI-6-6308		6,3 - 0,8	25,0	6,7	0,40	100	12135100606308	9,70	

GOGAPIN KKS-FV Flachsteckhülse mit Abzweigung isoliert / insulated piggyback flat connector sleeve

Material / material: Messing, gal. verzinkt / brass tin-plated
Material Isolation / insulation: PVC mit Isolationscrimp / vinyl with copper sleeve
Temperaturbereich / temperature range: -10°C - +75°C
Zulassung / approval: teilweise / partly UL listed

PVC

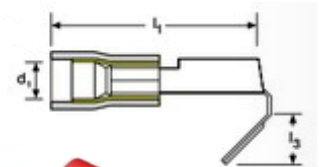

FC	Typ type	Bereich mm ² range	Steckgröße mm tab size	Abmessung mm dimensions mm				VPE Stk. PU	ArtNr	€/100 Stk. /100 pcs.
RT	KKS-FV-1,5-6308	0,5 - 1,5	6,3 - 0,8	22,5	4,1	8,2	0,4	100	12136000156308	11,30
BL	KKS-FV-2,5-6308	1,5 - 2,5	6,3 - 0,8	23,0	5,0	8,2	0,4	100	12136000256308	10,70
GE	KKS-FV-6-6308	4 - 6	6,3 - 0,8	26,0	6,6	8,2	0,4	100	12136000606308	14,93

Preise gültig ab 01.01.2024 exkl. MwSt., freibleibend, Auftragsrabatt auf Anfrage /
 prices are valid from 01.01.2024 excl. VAT, subject to change, discounts upon request
 sonst. Konditionen siehe www.gogatec.com/AGB.pdf, techn. Änderungen vorbehalten /
 terms & conditions can be found on our website: www.gogatec.com/AGB.pdf; error, technical modifications and variations are reserved

Passende Werkzeuge siehe GOGATOOL Katalog / for appropriate tools please see GOGATOOL catalog

GOGAPIN KKS-FS Flachstecker isoliert / insulated flat connector

Material / material: Messing, gal. verzinkt / brass tin-plated
Material Isolation / insulation: PVC mit Isolationscrimp / vinyl with copper sleeve
Temperaturbereich / temperature range: -10°C - +75°C
Zulassung / approval: teilweise / partly UL listed

PVC

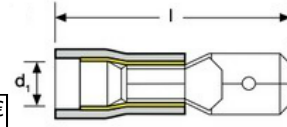

FC	Typ type	Bereich mm ² range	Steckgröße mm tab size	Abmessung mm dimensions mm			VPE Stk. PU	ArtNr	€/100 Stk. /100 pcs.
RT	KKS-FS-1,5-2805	0,5 - 1,5	2,8 - 0,5	22,0	4,1	0,25	100	12134000152805	5,98
	KKS-FS-1,5-2808		2,8 - 0,8	22,0	4,1	0,40	100	12134000152808	5,98
	KKS-FS-1,5-4805	4,8 - 0,5	22,0	4,1	0,25	100	12134000154805	6,60	
	KKS-FS-1,5-4808	4,8 - 0,8	22,0	4,1	0,40	100	12134000154808	6,93	
	KKS-FS-1,5-6308	6,3 - 0,8	22,0	4,1	0,40	100	12134000156308	6,99	
BL	KKS-FS-2,5-4808	1,5 - 2,5	4,8 - 0,8	22,5	5,0	0,40	100	12134000254808	7,38
	KKS-FS-2,5-6308		6,3 - 0,8	22,5	5,0	0,40	100	12134000256308	6,99
GE	KKS-FS-6-6308	4 - 6	6,3 - 0,8	24,5	6,6	0,40	100	12134000606308	8,49

GOGAPIN KKS-RS Rundstecker isoliert / insulated round pin plug

Material / material: Messing & E-CU, gal. verzinkt / brass tin-plated
Material Isolation / insulation: PVC mit Isolationscrimp / vinyl with copper sleeve
Temperaturbereich / temperature range: -10°C - +75°C
Zulassung / approval: teilweise / partly UR listed

PVC

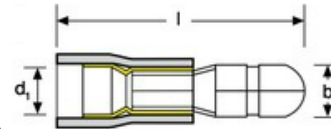

FC	Typ type	Bereich mm ² range	für Stecker Ø for connector	Abmessung mm dimensions mm				VPE Stk. PU	ArtNr	€/100 Stk. /100 pcs.
RT	KKS-RS-1,5-4	0,5 - 1,5	4	21,5	4,0	0,4	4,0	100	121370001504	5,90
BL	KKS-RS-2,5-4	1,5 - 2,5	4	21,7	4,0	0,4	4,7	100	121370002504	8,43
	KKS-RS-2,5-5		5	21,2	5,0	0,4	4,7	100	121370002505	6,13
GE	KKS-RS-6-5	4 - 6	5	24,0	5,0	0,4	6,5	100	121370006005	13,71

GOGAPIN KKS-RSVI Rundsteckhülse vollisoliert / fully insulated round socket

Material / material: Messing & E-CU, gal. verzinkt / brass tin-plated
Material Isolation / insulation: PVC mit Isolationscrimp / vinyl with copper sleeve
Temperaturbereich / temperature range: -10°C - +75°C
Zulassung / approval: teilweise / partly UR listed

PVC

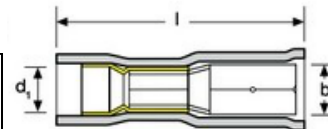

FC	Typ type	Bereich mm ² range	für Stecker Ø for connector	Abmessung mm dimensions mm				VPE Stk. PU	ArtNr	€/100 Stk. /100 pcs.
RT	KKS1-RHVI-1,5-4	0,5 - 1,5	4	25,3	3,9	0,4	4,3	100	121376001504	7,50
BL	KKS1-RHVI-2,5-4	1,5 - 2,5	4	25,2	3,9	0,4	5,0	100	121376002504	7,89
	KKS1-RHVI-2,5-5		5	27,0	4,9	0,4	5,0	100	121376002505	7,89
GE	KKS1-RHVI-6-5	4 - 6	5	27,5	4,9	0,4	6,8	100	121376006005	10,90

Preise gültig ab 01.01.2024 exkl. MwSt., freibleibend, Auftragsrabatt auf Anfrage /
 prices are valid from 01.01.2024 excl. VAT, subject to change, discounts upon request
 sonst. Konditionen siehe www.gogatec.com/AGB.pdf, techn. Änderungen vorbehalten /
 terms & conditions can be found on our website: www.gogatec.com/AGB.pdf; error, technical modifications and variations are reserved

Passende Werkzeuge siehe GOGATOOL Katalog / for appropriate tools please see GOGATOOL catalog

GOGAPIN KKS-SVSS Stoßverbinder mit Schrumpfschlauchisolation / butt-connector with shrinking tube insulation

Material / material: E-CU gal Sn. / E-CU tin-plated
 Material Isolation / insulation: Polyolefin mit Innenkleber / polyolefine with inner adhesive
 Schrumpftemperatur / shrinking temperature: 125°C
 Durchschlagsfestigkeit / dielectric strength: 14 kV/mm

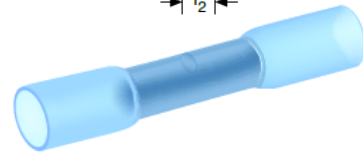
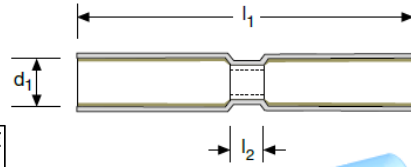

FC	Typ type	Bereich mm ² range	Abmessung mm l1 l2 s dimensions mm	VPE Stk. PU	ArtNr	€/100 Stk. /100 pcs
RT	KKS-SVSS-1,5	0,5 - 1,5	36 15,0 0,8	100	1213820015	41,51
BL	KKS-SVSS-2,5	1,5 - 2,5	36 15,0 0,9	100	1213820025	47,46
GE	KKS-SVSS-6	4 - 6	41 15,0 1,0	100	1213820060	61,80

GOGAPIN KKS-LVSS Lötverbinder mit Schrumpfschlauchisolation / solder-connector with shrinking tube insulation

Material / material: E-CU gal Sn. / E-CU tin-plated
 Material Isolation / insulation: Polyolefin mit Innenkleber / polyolefine with inner adhesive
 Schrumpftemperatur / shrinking temperature: 125°C
 Durchschlagsfestigkeit / dielectric strength: 14 kV/mm

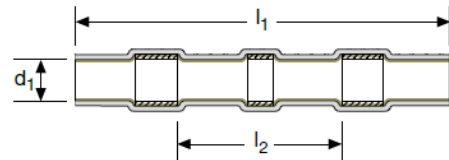

FC	Typ type	Bereich mm ² range	Abmessung mm l1 l2 s d1 dimensions mm	VPE Stk. PU	ArtNr	€/100 Stk. /100 pcs
RT	KKS-LVSS-1,5	0,5 - 1,5	40 15,2 0,5 2,7	100	1213830015	84,90
BL	KKS-LVSS-2,5	1,5 - 2,5	40 15,2 0,7 4,5	100	1213830025	90,30
GE	KKS-LVSS-6	4 - 6	40 15,2 0,7 6,0	100	1213830060	109,90

GOGAPIN SB Löt- und Stoßverbinder mit Schrumpfschlauchisolation Sortimentbox / solder- and butt-connector with shrinking tube insulation plastic box

FC	Typ type	Bereich mm ² range	VPE Stk. PU	ArtNr	€/Stk. /pc
RT	KKS-SVSS-1,5	0,5 - 1,5	100	121380000SB1	262,00
BL	KKS-SVSS-2,5	1,5 - 2,5	100		
GE	KKS-SVSS-6	4 - 6	20		
RT	KKS-LVSS-1,5	0,5 - 1,5	50		
BL	KKS-LVSS-2,5	1,5 - 2,5	50		
GE	KKS-LVSS-6	4 - 6	10		



Preise gültig ab 01.01.2024 exkl. MwSt., freibleibend, Auftragsrabatt auf Anfrage / prices are valid from 01.01.2024 excl. VAT, subject to change, discounts upon request
 sonst. Konditionen siehe www.gogatec.com/AGB.pdf, techn. Änderungen vorbehalten / terms & conditions can be found on our website: www.gogatec.com/AGB.pdf; error, technical modifications and variations are reserved

Passende Werkzeuge siehe GOGATOOL Katalog /

GOGAPIN KKS-GKSS Quetschkabelschuh-Gabel mit Schrumpfschlauchisolation / cable lug fork with shrinking tube insulation

Material / material: E-Cu, gal. Sn
Material Isolation / insulation: Polyolefin mit Innenkleber / polyolefine with inner adhesive
Temperaturbereich / temperature range: -55°C - +125°C
Schrumpftemperatur / shrinking temperature: +125°C
Durchschlagsfestigkeit / dielectric strength: 14 kV/mm

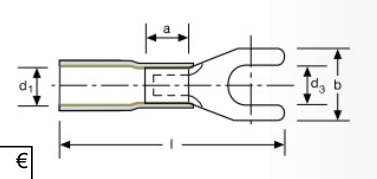

FC	Typ type	Bereich mm ² range	Gabel für fork size	Abmessung mm dimensions mm						VPE Stk. PU	ArtNr	€/100 Stk. /100 pcs.
				d3	b	d1	l	a	s			
RT	KKS-GKSS-1,5-M4	0,5- 1,5	M4	4,3	6,4	1,9	26,9	5,0	0,7	100	121321001504	66,20
	KKS-GKSS-1,5-M5		M5	5,3	8,0	1,9	26,9	5,0	0,7	100	121321001505	74,90
BL	KKS-GKSS-2,5-M4	1,5- 2,5	M4	4,3	6,4	2,5	26,5	5,0	0,7	100	121321002504	73,80
	KKS-GKSS-2,5-M5		M5	5,3	8,0	2,5	26,5	5,0	0,7	100	121321002505	75,40
GE	KKS-GKSS-6-M4	4-6	M4	4,3	8,2	3,6	33,0	6,0	0,7	100	121321006004	77,90
	KKS-GKSS-6-M5		M5	5,3	9,0	3,6	33,0	6,0	0,7	100	121321006005	92,70

GOGAPIN KKS-RKSS Quetschkabelschuh-Ring m. Schrumpfschlauchisolation / cable lug ring w. shrinking tube insulation

Material / material: E-Cu, gal. Sn
Material Isolation / insulation: Polyolefin mit Innenkleber / polyolefine with inner adhesive
Temperaturbereich / temperature range: -55°C - +125°C
Schrumpftemperatur / shrinking temperature: +125°C
Durchschlagsfestigkeit / dielectric strength: 14 kV/mm

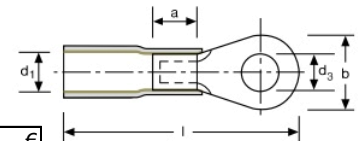

FC	Typ type	Bereich mm ² range	Loch für hole size	Abmessung mm dimensions mm						VPE Stk. PU	ArtNr	€/100 Stk. /100 pcs.
				d3	b	d1	l	a	s			
RT	KKS-RKSS-1,5-M4	0,5-1,5	M4	4,3	8,0	1,9	26,5	5,0	0,7	100	121313001504	65,90
	KKS-RKSS-1,5-M5		M5	5,3	8,0	1,9	26,5	5,0	0,7	100	121313001505	69,20
	KKS-RKSS-1,5-M6		M6	6,4	11,6	1,9	32,2	5,0	0,7	100	121313001506	75,20
	KKS-RKSS-1,5-M8		M8	8,4	11,6	1,9	32,2	5,0	0,7	100	121313001508	74,90
	KKS-RKSS-1,5-M10		M10	10,5	13,7	1,9	36,2	5,0	0,7	100	121313001510	72,10
BL	KKS-RKSS-2,5-M4	1,5-2,5	M4	4,3	8,5	2,5	27,3	5,0	0,7	100	121313002504	65,90
	KKS-RKSS-2,5-M5		M5	5,3	9,5	2,5	27,3	5,0	0,7	100	121313002505	69,20
	KKS-RKSS-2,5-M6		M6	6,4	12,0	2,5	31,7	5,0	0,7	100	121313002506	74,90
	KKS-RKSS-2,5-M8		M8	8,4	12,0	2,5	31,7	5,0	0,7	100	121313002508	74,90
	KKS-RKSS-2,5-M10		M10	10,5	13,7	2,5	36,0	5,0	0,7	100	121313002510	76,10
GE	KKS-RKSS-6-M4	4 - 6	M4	4,3	9,5	3,6	32,7	6,0	0,7	100	121313006004	100,60
	KKS-RKSS-6-M5		M5	5,3	9,5	3,6	32,7	6,0	0,7	100	121313006005	100,60
	KKS-RKSS-6-M6		M6	6,4	12,0	3,6	39,0	6,0	0,7	100	121313006006	114,90
	KKS-RKSS-6-M8		M8	8,4	15,0	3,6	41,2	6,0	0,7	100	121313006008	115,30
	KKS-RKSS-6-M10		M10	10,5	15,0	3,6	41,2	6,0	0,7	100	121313006010	114,00

Preise gültig ab 01.01.2024 exkl. MwSt., freibleibend, Auftragsrabatt auf Anfrage /
 prices are valid from 01.01.2024 excl. VAT, subject to change, discounts upon request
 sonst. Konditionen siehe www.gogatec.com/AGB.pdf, techn. Änderungen vorbehalten /
 terms & conditions can be found on our website: www.gogatec.com/AGB.pdf; error, technical modifications and variations are reserved.

GOGAPIN KSL-LVSS Lötverbinder Schirmschluss Tyco / solder shield connectors

Material / material: strahlenvernetztes / irradiated Polyolefin, Lot Cd18, Flussmittel / flux ROM1
Temperaturbereich / temperature range: -55°C - +125°C

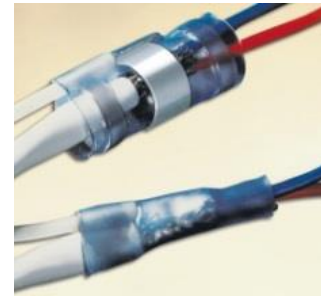

Anschluss von Erdungsleitern an Kabelschirmen / connection of grounding conductors to cable shields
Anschluss von Koaxialkabeln / connection of coaxial cables

Typ	Innen-Ø	FC	Länge	VPE	ArtNr	€
type	inner- Ø	colour	length	Stk. PU		/100 Stk. /100 pcs.
KSL-LVSS-5	4,5	TR	42	100	1226830045	120,40
KSL-LVSS-6	6	TR			1226830060	163,00
KSL-LVSS-7	7	TR			1226830070	628,00
KSL-LVSS-9	8,7	TR			1226830087	257,00
KSL-LVSS-11	10,7	TR			1226830107	296,00
KSL-LVSS-13	13	TR			1226830130	849,00



Preise gültig ab 01.01.2024 exkl. MwSt., freibleibend, Auftragsrabatt auf Anfrage /
 prices are valid from 01.01.2024 excl. VAT, subject to change, discounts upon request
 sonst. Konditionen siehe www.gogatec.com/AGB.pdf, techn. Änderungen vorbehalten /
 terms & conditions can be found on our website: www.gogatec.com/AGB.pdf; error, technical modifications and variations are reserved.

Passende Werkzeuge siehe GOGATOOL Katalog / for appropriate tools please see GOGATOOL catalog

GOGAPIN KKS-PV Parallelverbinder isoliert / insulated parallel connectors

Material / material: E-CU gal Sn. / E-CU tin-plated

Material isolation / insulation: PVC / vinyl

Temperaturbereich / temperature range: -10°C - +75°C

PVC

FC	Typ	Bereich	Abmessung mm			VPE	ArtNr	€/100 Stk.
	type	mm ²	l1	l2	s	Stk. PU		/100 pcs.
RT	KKS-PV-1,5	0,5 - 1,5	17,0	7,0	0,8	1000	1213860015	12,32
BL	KKS-PV-2,5	1,5 - 2,5	17,0	7,0	0,8	1000	1213860025	22,68
GE	KKS-PV-6	4 - 6	21,0	7,0	1,0	1000	1213860060	28,26

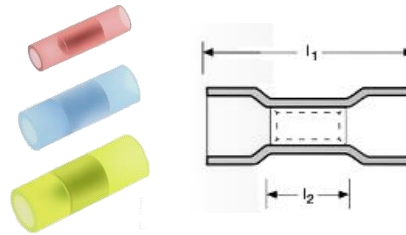

GOGAPIN KKS-EV Endverbinder isoliert / insulated close-end connectors

Material / material: E-CU gal Sn. / E-CU tin-plated

Material isolation / insulation: PA

Temperaturbereich / temperature range: -60°C - +105°C

Polyamid / polyamide

FC	Typ	A/B	Bereich	Abmessung mm				VPE	ArtNr	€/100 Stk.
	type	A/B	mm ²	d	d1	l1	l2	Stk. PU		/100 pcs.
BL	KKS-EV-2,5	A	1,5 - 2,5	6,2	3,2	15,5	7,0	100	1213870025	18,07
GE	KKS-EV-6	A	4 - 6	9,5	5,0	17,5	6,0	100	1213870060	46,66
NT	KKS-EV-1,5	A	0,5 - 1,5	6,2	2,2	15,2	8	100	1213870015	11,47
NT	KKS-EV-1,5	B	0,5 - 1,5	8	2,3	21	7	100	1213870015NA	11,66
NT	KKS-EV-2,5	B	1,5 - 2,5	8	3,1	21	7	100	1213870025NA	11,01
NT	KKS-EV-6	B	2,5 - 6	10	4	25,5	7,5	100	1213870060NA	20,12
NT	KKS-EV-10	B	4 - 10	12	4,4	29,8	8,5	100	1213870100NA	35,79

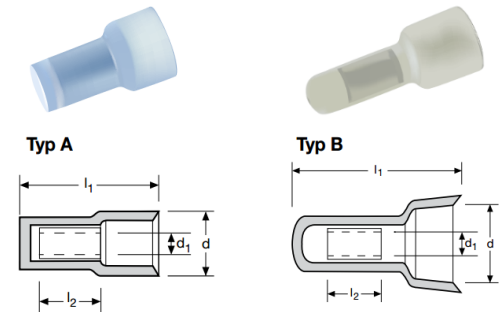

GOGAPIN KKS-SCHV Schnellverbinder isoliert / insulated quick splice connectors

Material / material: Messing galv. verzinkt / galvanised tin-plated brass

Material isolation / insulation: PP

Temperaturbereich / temperature range: +0°C - +105°C

Polypropylen / Polypropylene

FC	Typ	Bereich	Abmessung mm		Abzweig bis	VPE	ArtNr	€/100 Stk.
	type	mm ²	l	b	mm ²	Stk. PU		/100 pcs.
RT	KKS-SCHV-1,5	0,5 - 1,5	20,0	27,0	1,0	1000	1213840015	11,81
BL	KKS-SCHV-2,5	1,5 - 2,5	20,0	27,0	2,5	1000	1213840025	12,32
GE	KKS-SCHV-6	4 - 6	20,5	24,5	4,0	1000	1213840060	15,75

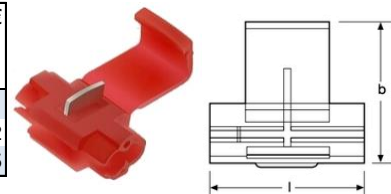

GOGAPIN SHIELD-KON® Schnellverbinder isoliert / one-piece connector for wrap-around crimping

Einteiliger Verbinder im "Roll"-Design / one-piece connector for wrap-around crimping

Material / material: E-CU nach CDA 110, verzinkt / E-CU acc. To CDA 110, tin-plated

Material isolation / insulation: Polyesterfilm laminiert / polyesterfilm laminated

Temperaturbereich / temperature range: -65°C - +125°C

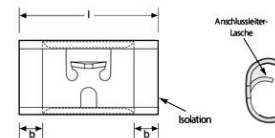

FC	Typ	Bereich	Anschlussleiter max.	Abmessung mm		VPE	ArtNr	€/100 Stk.
	type	mm ²	max. conductors	l	b	Stk. PU		/100 pcs.
RT	KKS-RSK5101	1,27 - 2,28	2 x 0,25	15,2	2,8	100	1213890015	128,20
BL	KKS-RSK5201	2,29 - 3,65	2 x 0,25 / 1 x 0,5	15,2	2,8	100	1213890025	162,00
GE	KKS-RSK5301	3,66 - 5,12	2 x 0,25 / 1 x 0,5	15,2	2,8	100	1213890060	217,00
GN	KKS-RSK5401	5,13 - 7,62	2 x 0,25 / 1 x 0,75	15,2	2,8	100	1213890100	304,00



Preise gültig ab 01.01.2024 exkl. MwSt., freibleibend, Auftragsrabatt auf Anfrage /

prices are valid from 01.01.2024 excl. VAT, subject to change, discounts upon request

sonst. Konditionen siehe www.gogatec.com/AGB.pdf, techn. Änderungen vorbehalten /

terms & conditions can be found on our website: www.gogatec.com/AGB.pdf; error, technical modifications and variations are reserved