

GOGAPLUG M12 Stift auf Ventilstecker Bauform A / M12 plug on valve plug form A

Nennstrom ohne/mit Beschaltung / nominal current without/with circuit: 4/3 A
 Nennspannung ohne/mit Beschaltung / nominal voltage without/with circuit: 250/24 V
 Polzahl / number of poles: 2 + 2PE
 Beschaltung / circuit: LED + VDR 24 V
 Temperaturbereich Stecker / temperature range plug: -25°C - + 80°C
 Temperaturbereich Kabel (statisch) / temperature range cable (static): -25°C - + 80°C
 Temperaturbereich Kabel (dynamisch) / temperature range cable (dynamic): -5°C - + 80°C
 Isolationswiderstand / insulation resistance: $\geq 100 \text{ M } \Omega$
 Verschmutzungsgrad / pollution degree: 3
 Schutzklasse / protection grade: IP 67
 Gehäusematerial / enclosure material: PA 6 GF
 Körpermaterial / body material: PUR
 Kontaktwiderstand / contact resistance: $\leq 4 \text{ m } \Omega$
 Kontakmaterial / contact material: CuZn
 Kontaktoberflächenmaterial / contact surface material: Au vernickelt / nickel plated
 Erdposition / earth position: H6/H12
 Dichtung / sealing: NBR
 Schraubverriegelung / screw locking: M3 verzinkt / zinc plated
 Kabeltype / cable typ: PVC/PUR / PVC type H03VV-F 3G0,75
 Kabelquerschnitt / conductor cross section: 0,34 mm² (AWG22)
 Kabelstruktur / cable structure: 42 x 0,10 mm
 Kabeldurchmesser / cable diameter: 5,0 mm \pm 0,2
 Kabelfarben / conductor colors: braun, blau, schwarz / brown, blue, black
 Kabelmantelfarbe / cable mantle color: schwarz / black
 Leiterwiderstand / conductor resistance: $\leq 58,2 \Omega/\text{km}$
 Nennspannung Kabel / cable nominal voltage: 300 V
 Testspannung Kabel / testing voltage cable: 2.000 V
 Material Leiterisolierung / material conductor insulation: PVC
 Externe Isolierung / external insulation: PVC/PUR $\geq 0,2\text{mm}$ / PVC
 Biegeradius / bending diameter: 20 x Kabeldurchmesser / external diameter
 Verfahrensgeschwindigkeit / traversing rate: 120 m/min
 Beschleunigung / acceleration: 3 m/s²
 Flammenbeständig / flame resistance: Ja / yes
 Halogenfrei / halogen-free: Nein / no
 Material Gegenmutter / material lock nut: CuZn vernickelt / nickel-plated

Andere Beschaltungen auf Anfrage / other circuits upon request

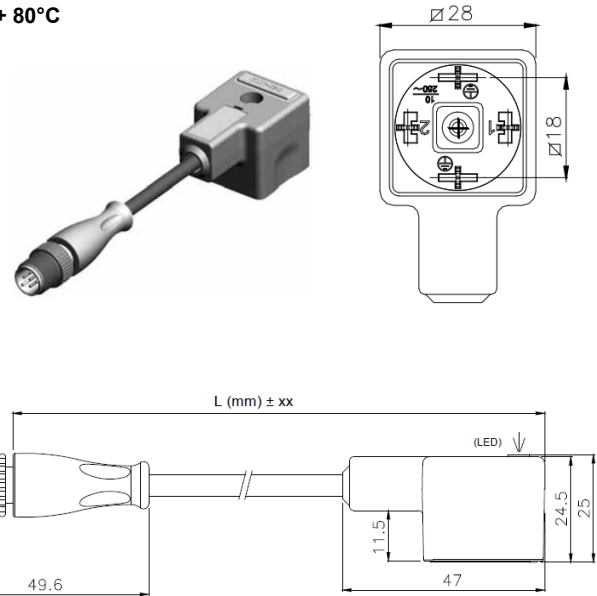

| Kontaktabstand mm contact distance | Länge m length | ArtNr PVC/PUR-Leitung PVC/PUR-wire | € /Stk. /pc. | ArtNr PVC-Leitung PVC-wire | € /Stk. /pc. |
|----------------------------------------------------|----------------------|------------------------------------------|--------------------|----------------------------------|--------------------|
| ohne Beschaltung / without circuit | | | | | |
| 18 | 0,3 | 34-PC3AZ00-030-120 | 9,33 | 34-PC3AZ00-030-020 | 9,26 |
| | 0,6 | 34-PC3AZ00-060-120 | 9,70 | 34-PC3AZ00-060-020 | 9,56 |
| | 1,5 | 34-PC3AZ00-150-120 | 10,83 | 34-PC3AZ00-150-020 | 10,48 |
| | 3 | 34-PC3AZ00-300-120 | 12,70 | 34-PC3AZ00-300-020 | 12,01 |
| mit Beschaltung LED + VDR / with circuit LED + VDR | | | | | |
| 18 | 0,3 | 34-PC3AZA0-030-120 | 12,21 | 34-PC3AZA0-030-020 | 12,14 |
| | 0,6 | 34-PC3AZA0-060-120 | 12,59 | 34-PC3AZA0-060-020 | 12,45 |
| | 1,5 | 34-PC3AZA0-150-120 | 13,71 | 34-PC3AZA0-150-020 | 13,36 |
| | 3 | 34-PC3AZA0-300-120 | 15,58 | 34-PC3AZA0-300-020 | 14,89 |

Auf Anfrage auch mit UL-Zulassung erhältlich / on request also with UL-certificate available

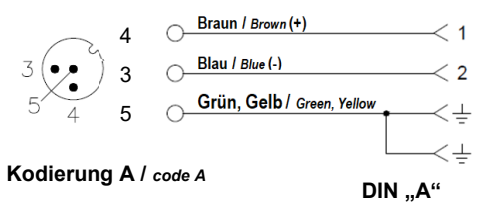

Ohne Beschaltung / without circuit

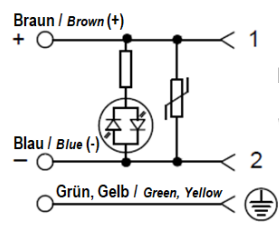

Mit Beschaltung LED+VDR / with circuit LED+VDR

Preise gültig ab 01.01.2024 exkl. MwSt., freibleibend, Auftragsrabatt auf Anfrage / prices are valid from 01.01.2024 excl. VAT, subject to change, discounts upon request
 sonst. Konditionen siehe www.gogatec.com/AGB.pdf, techn. Änderungen vorbehalten / terms & conditions can be found on our website: www.gogatec.com/AGB.pdf; error, technical modifications and variations are reserved

GOGAPLUG M12 Stift auf Ventilstecker Bauform B / M12 plug on valve plug form B

Nennstrom ohne/mit Beschaltung / nominal current without/with circuit: 4 A
Nennspannung ohne/mit Beschaltung / nominal voltage without/with circuit: 250/24 V
Polzahl / number of poles: 2 + 2PE
Beschaltung / circuit: LED + VDR 24 V
Temperaturbereich Stecker / temperature range plug: -25°C - + 80°C
Temperaturbereich Kabel (statisch) / temperature range cable (static): -25°C - + 80°C
Temperaturbereich Kabel (dynamisch) / temperature range cable (dynamic): -5°C - + 80°C
Isolationswiderstand / insulation resistance: $\geq 100 \text{ M } \Omega$
Verschmutzungsgrad / pollution degree: 3
Schutzklasse / protection grade: IP 67
Gehäusematerial / enclosure material: PA 6 GF
Körpermaterial / body material: PUR
Kontaktwiderstand / contact resistance: $\leq 4 \text{ m } \Omega$
Kontakmaterial / contact material: CuZn
Kontaktoberflächenmaterial / contact surface material: Au vernickelt / nickel plated
Erdposition / earth position: H12
Dichtung / sealing: NBR
Schraubverriegelung / screw locking: M3 verzinkt / zinc plated
Kabeltype / cable typ: PVC/PUR / PVC
Kabelquerschnitt / conductor cross section: $0,34 \text{ mm}^2$ (AWG22)
Kabelstruktur / cable structure: $42 \times 0,10 \text{ mm}$
Kabeldurchmesser / cable diameter: $5,0 / 4,7 \text{ mm} \pm 0,2$
Kabelfarben / conductor colors: braun, blau, schwarz / brown, blue, black
Kabelmantelfarbe / cable mantle color: schwarz / black
Leiterwiderstand / conductor resistance: $\leq 58,2 \Omega/\text{km}$
Nennspannung Kabel / cable nominal voltage: 300 V
Testspannung Kabel / testing voltage cable: 2.000 V
Material Leiterisolierung / material conductor insulation: PVC
Externe Isolierung / external insulation: PVC/PUR $\geq 0,2\text{mm}$ / PVC
Biegeradius / bending diameter: $20 \times$ Kabeldurchmesser / external diameter
Verfahrgeschwindigkeit / traversing rate: 120 m/min
Beschleunigung / acceleration: 3 m/s^2
Flammenbeständig / flame resistance: Ja / yes
Halogenfrei / halogen-free: Nein / no
Material Gegenmutter / material lock nut: CuZn vernickelt / nickel-plated

Andere Beschaltungen auf Anfrage /
other circuits upon request

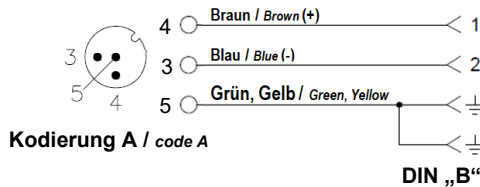
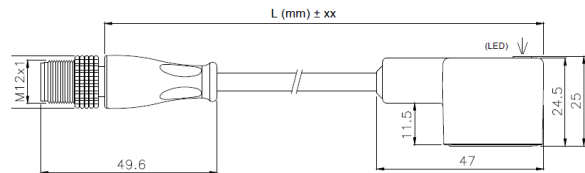
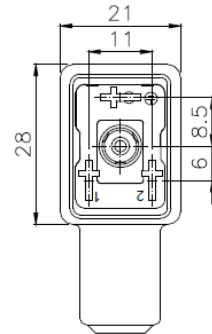
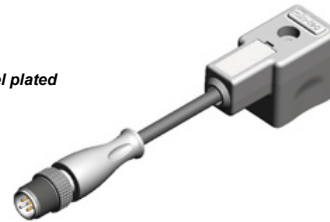

Ohne
Beschaltung /
without circuit

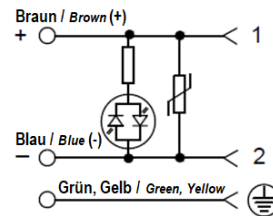

Mit Beschaltung
LED+VDR /
with circuit LED+VDR

| Kontaktabstand mm contact distance | Länge m length | ArtNr PVC/PUR-Leitung PVC/PUR-wire | € /Stk. /pc. | ArtNr PVC-Leitung PVC-wire | € /Stk. /pc. |
|----------------------------------------------------|----------------------|------------------------------------------|--------------------|----------------------------------|--------------------|
| ohne Beschaltung / without circuit | | | | | |
| 11 | 0,3 | 34-PC3BD00-030-120 | 8,79 | 34-PC3BD00-030-020 | 8,73 |
| | 0,6 | 34-PC3BD00-060-120 | 9,17 | 34-PC3BD00-060-020 | 9,03 |
| | 1,5 | 34-PC3BD00-150-120 | 10,29 | 34-PC3BD00-150-020 | 9,95 |
| | 3 | 34-PC3BD00-300-120 | 12,16 | 34-PC3BD00-300-020 | 11,47 |
| mit Beschaltung LED + VDR / with circuit LED + VDR | | | | | |
| 11 | 0,3 | 34-PC3BDA0-030-120 | 12,00 | 34-PC3BDA0-030-020 | 11,93 |
| | 0,6 | 34-PC3BDA0-060-120 | 12,37 | 34-PC3BDA0-060-020 | 12,23 |
| | 1,5 | 34-PC3BDA0-150-120 | 13,50 | 34-PC3BDA0-150-020 | 13,15 |
| | 3 | 34-PC3BDA0-300-120 | 15,37 | 34-PC3BDA0-300-020 | 14,67 |

Auf Anfrage auch mit
UL-Zulassung erhältlich /
on request also with UL-certificate
available

Preise gültig ab 01.01.2024 exkl. MwSt., freibleibend, Auftragsrabatt auf Anfrage /
prices are valid from 01.01.2024 excl. VAT, subject to change, discounts upon request
sonst. Konditionen siehe www.gogatec.com/AGB.pdf, techn. Änderungen vorbehalten /
terms & conditions can be found on our website: www.gogatec.com/AGB.pdf; error, technical modifications and variations are reserved

GOGAPLUG M12 Stift auf Ventilstecker Bauform C / M12 plug on valve plug form C

Nennstrom ohne/mit Beschaltung / nominal current without/with circuit: 4/3 A
 Nennspannung ohne/mit Beschaltung / nominal voltage without/with circuit: 250/24 V
 Polzahl / number of poles: 2 + 2PE
 Beschaltung / circuit: LED + VDR 24 V
 Temperaturbereich Stecker / temperature range plug: -25°C - + 80°C
 Temperaturbereich Kabel (statisch) / temperature range cable (static): -25°C - + 80°C
 Temperaturbereich Kabel (dynamisch) / temperature range cable (dynamic): -5°C - + 80°C
 Isolationswiderstand / insulation resistance: $\geq 100 \text{ M } \Omega$
 Verschmutzungsgrad / pollution degree: 3
 Schutzklasse / protection grade: IP 67
 Gehäusematerial / enclosure material: PA 6 GF
 Körpermaterial / body material: PUR
 Kontaktwiderstand / contact resistance: $\leq 4 \text{ m } \Omega$
 Kontakmaterial / contact material: CuZn
 Kontaktoberflächenmaterial / contact surface material: Au vernickelt / nickel plated
 Erdposition / earth position: H6/H12
 Dichtung / sealing: NBR
 Schraubverriegelung / screw locking: M2,5 verzinkt / zinc plated
 Kabeltype / cable typ: PVC/PUR / PVC
 Kabelquerschnitt / conductor cross section: 0,34 mm² (AWG22)
 Kabelstruktur / cable structure: 42 x 0,10 mm
 Kabeldurchmesser / cable diameter: 5,0 / 4,7 mm \pm 0,2
 Kabelfarben / conductor colors: braun, blau, schwarz / brown, blue, black
 Kabelmantelfarbe / cable mantle color: schwarz / black
 Leiterwiderstand / conductor resistance: $\leq 58,2 \Omega/\text{km}$
 Nennspannung Kabel / cable nominal voltage: 300 V
 Testspannung Kabel / testing voltage cable: 2.000 V
 Material Leiterisolierung / material conductor insulation: PVC
 Externe Isolierung / external insulation: PVC/PUR $\geq 0,2\text{mm}$ / PVC
 Biegeradius / bending diameter: 20 x Kabeldurchmesser / external diameter
 Verfahrgeschwindigkeit / traversing rate: 120 m/min
 Beschleunigung / acceleration: 3 m/s²
 Flammenbeständig / flame resistance: Ja / yes
 Halogenfrei / halogen-free: Nein / no
 Material Gegenmutter / material lock nut: CuZn vernickelt / nickel-plated

Andere Beschaltungen auf Anfrage / other circuits upon request

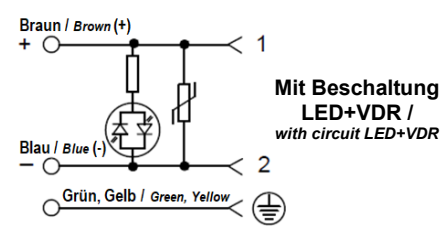
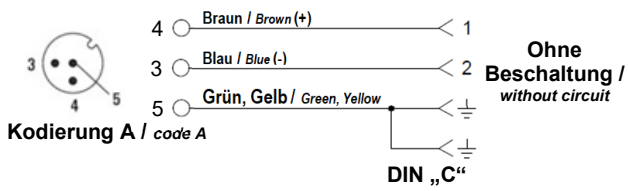
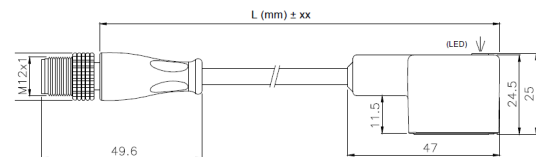
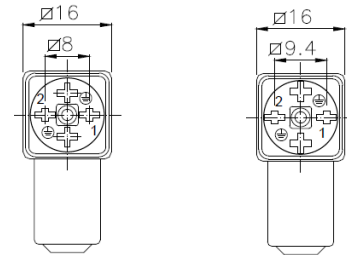

Auf Anfrage auch mit UL-Zulassung erhältlich / on request also with UL-certificate available

| Kontaktabstand mm | Länge m | ArtNr PVC/PUR-Leitung | € /Stk. | ArtNr PVC-Leitung | € /Stk. |
|----------------------------------------|------------|--------------------------|------------|----------------------|------------|
| contact distance | length | PVC/PUR-wire | /pc. | PVC-wire | /pc. |
| ohne Beschaltung / without circuit | | | | | |
| 9,4 | 0,3 | 34-PC3DZ00-030-120 | 9,86 | 34-PC3DZ00-030-020 | 9,79 |
| | 0,6 | 34-PC3DZ00-060-120 | 10,24 | 34-PC3DZ00-060-020 | 10,10 |
| | 1,5 | 34-PC3DZ00-150-120 | 11,36 | 34-PC3DZ00-150-020 | 11,01 |
| | 3 | 34-PC3DZ00-300-120 | 13,23 | 34-PC3DZ00-300-020 | 12,54 |
| 8 | 0,3 | 34-PC3CZ00-030-120 | 9,86 | 34-PC3CZ00-030-020 | 9,79 |
| | 0,6 | 34-PC3CZ00-060-120 | 10,24 | 34-PC3CZ00-060-020 | 10,10 |
| | 1,5 | 34-PC3CZ00-150-120 | 11,36 | 34-PC3CZ00-150-020 | 11,01 |
| | 3 | 34-PC3CZ00-300-120 | 13,23 | 34-PC3CZ00-300-020 | 12,54 |
| mit LED + VDR / with circuit LED + VDR | | | | | |
| 9,4 | 0,3 | 34-PC3DZA0-030-120 | 12,85 | 34-PC3DZA0-030-020 | 12,78 |
| | 0,6 | 34-PC3DZA0-060-120 | 13,23 | 34-PC3DZA0-060-020 | 13,09 |
| | 1,5 | 34-PC3DZA0-150-120 | 14,35 | 34-PC3DZA0-150-020 | 14,00 |
| | 3 | 34-PC3DZA0-300-120 | 16,22 | 34-PC3DZA0-300-020 | 15,53 |
| 8 | 0,3 | 34-PC3CZA0-030-120 | 12,85 | 34-PC3CZA0-030-020 | 12,78 |
| | 0,6 | 34-PC3CZA0-060-120 | 13,23 | 34-PC3CZA0-060-020 | 13,09 |
| | 1,5 | 34-PC3CZA0-150-120 | 14,35 | 34-PC3CZA0-150-020 | 14,00 |
| | 3 | 34-PC3CZA0-300-120 | 16,22 | 34-PC3CZA0-300-020 | 15,53 |

Preise gültig ab 01.01.2024 exkl. MwSt., freibleibend, Auftragsrabatt auf Anfrage / prices are valid from 01.01.2024 excl. VAT, subject to change, discounts upon request
 sonst. Konditionen siehe www.gogatec.com/AGB.pdf, techn. Änderungen vorbehalten / terms & conditions can be found on our website: www.gogatec.com/AGB.pdf, error, technical modifications and variations are reserved

GOGAPLUG M12 Adapter Ventilstecker Bauform A / M12 adapter valve plug form A

Nennspannung / nominal voltage: 250 V / 3-polig / 3-poled

Nennstrom / nominal current: 4 A

Isolationswiderstand / isolation resistance: $\geq 10^9 \Omega$

Temperaturbereich / temperature range: -25°C - +80°C

Zulassungen / approvals: EN 175301-803 (EX DIN 43650)/61076-2-101

Schutzart / protection grade: IP 67

Verschlussystem / locking system: selbstversperrende M3 Ringmutter / with self-locking M3 ring nut

Material Gehäuse-Kabelanschluss / material enclosure cable connector: PUR



| Kontaktabstand mm contact distance | ArtNr ohne Beschaltung without circuit | €/Stk. /pc. | ArtNr mit Beschaltung with circuit | €/Stk. /pc. |
|------------------------------------------|----------------------------------------------|----------------|------------------------------------------|----------------|
| 18 | 34-SAZ300-000 | 11,78 | 34-SAZ3A0-000 | 15,88 |

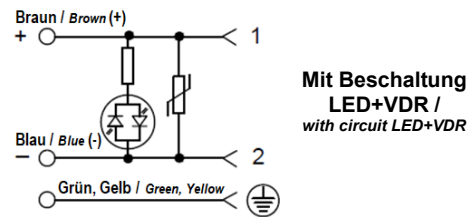
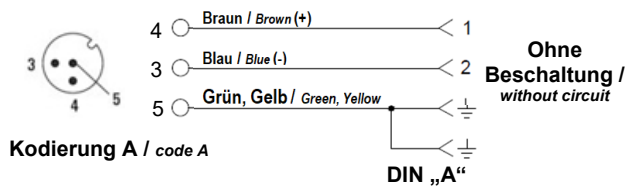
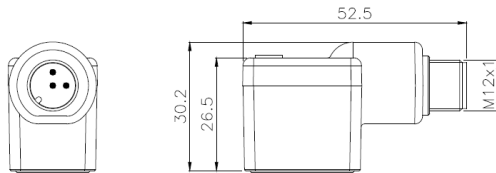
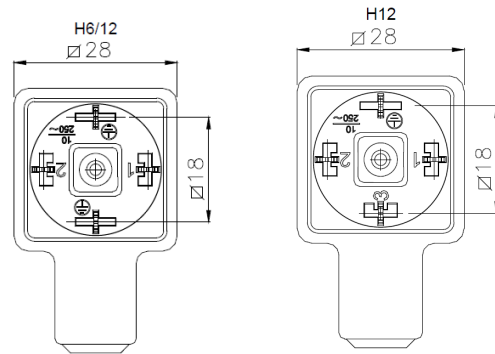

Preise gültig ab 01.01.2024 exkl. MwSt., freibleibend, Auftragsrabatt auf Anfrage /

prices are valid from 01.01.2024 excl. VAT, subject to change, discounts upon request

sonst. Konditionen siehe www.gogatec.com/AGB.pdf, techn. Änderungen vorbehalten /

terms & conditions can be found on our website: www.gogatec.com/AGB.pdf; error, technical modifications and variations are reserved

M12 – Ventilstecker Verbindungskabel / M12 - valve plug connection cable

Nennspannung / nominal voltage: 3-4 pol. (250 V) - 5 pol. (60 V)
Nennstrom / nominal current: 4 A
Isolationswiderstand / isolation resistance: $\geq 10^9 \Omega$
Steckzyklen / plugging cycles: max. 1.000
Temperaturbereich / temperature range: -25°C - +80°C

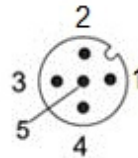

M12 Stecker 5 polig /
M12 plug 5 pole

Auf Anfrage auch mit
UL-Zulassung erhältlich /
on request also with UL-certificate
available

GOGAPLUG 2 Ventilstecker auf M12 Doppelverbinder H9 / 2 valve plugs on M12 double con. H9

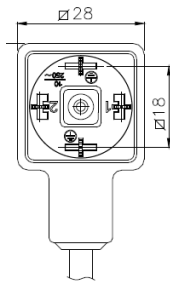

DIN Form A

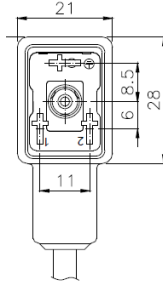

DIN Form B-Industrie

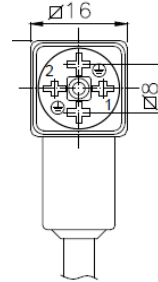

DIN Form C 8 mm

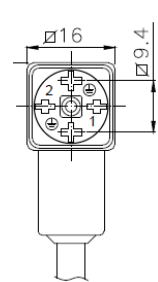

DIN Form C 9,4 mm



| Länge m | DIN Bauform mm | ArtNr PVC/PUR-Leitung | € /Stk. | ArtNr PVC-Leitung | € /Stk. |
|------------|-------------------|--------------------------|------------|----------------------|------------|
| length | DIN version | PVC/Pur-wire | /pc. | PVC-wire | /pc. |
| 1 | A | 34-YAZ00H9-100-120 | a.A. | 34-YAZ00H9-100-020 | a.A. |
| | C 8 | 34-YCZ00H9-100-120 | a.A. | 34-YCZ00H9-100-020 | a.A. |
| | C 9,4 | 34-YDZ00H9-100-120 | a.A. | 34-YDZ00H9-100-020 | a.A. |
| 1,5 | A | 34-YAZ00H9-150-120 | a.A. | 34-YAZ00H9-150-020 | a.A. |
| | C 8 | 34-YCZ00H9-150-120 | a.A. | 34-YCZ00H9-150-020 | a.A. |
| | C 9,4 | 34-YDZ00H9-150-120 | a.A. | 34-YDZ00H9-150-020 | a.A. |
| 2 | A | 34-YAZ00H9-200-120 | a.A. | 34-YAZ00H9-200-020 | a.A. |
| | C 8 | 34-YCZ00H9-200-120 | a.A. | 34-YCZ00H9-200-020 | a.A. |
| | C 9,4 | 34-YDZ00H9-200-120 | a.A. | 34-YDZ00H9-200-020 | a.A. |

a. A. = auf Anfrage / upon request

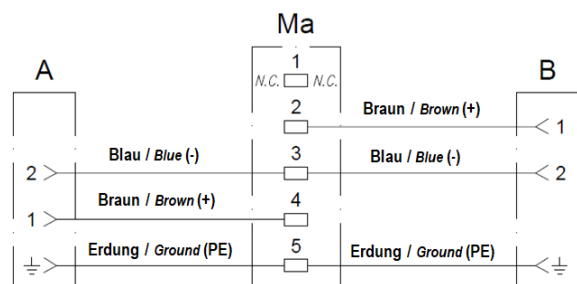
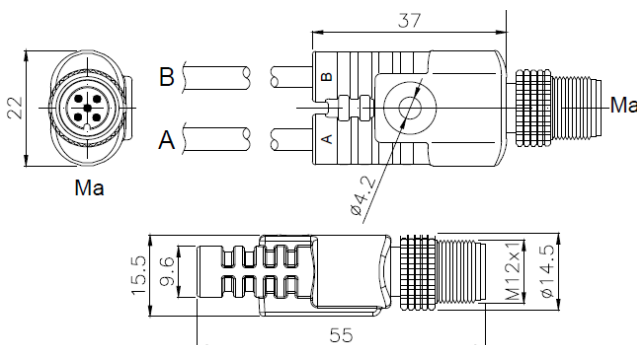

Preise gültig ab 01.01.2024 exkl. MwSt., freibleibend, Auftragsrabatt auf Anfrage /
prices are valid from 01.01.2024 excl. VAT, subject to change, discounts upon request
sonst. Konditionen siehe www.gogatec.com/AGB.pdf, techn. Änderungen vorbehalten /
terms & conditions can be found on our website: www.gogatec.com/AGB.pdf; error, technical modifications and variations are reserved