

**GOGATool CT-U Crimpwerkzeug / crimping tool**

- mit „easy change“ Schnellverriegelung, ohne Rändelschrauben, ohne Werkzeuge / with "easy change" quick lock, without knurled screws, without tools
- einfacher Wechsel der Crimpeinsätze / easy change of crimp inserts
- Äußerst robust und zuverlässig / Extremely robust and reliable
- Zwangssperre mit Entriegelung garantiert vollständige Vercrimpung / Positive lock with release guarantees complete crimping
- Einstellbarer Pressdruck / Adjustable crimping pressure
- Verschleißfestes Schnellwechselsystem ohne ausleiernde Federn / Wear-resistant quick-change system without wearing out springs
- Dadurch auch im Fahrzeug-, Flugzeugbau und in der Automatisierung verwendbar / Can therefore also be used at vehicle construction, aircraft construction and automation
- Matt verchromter Werkzeugrahmen / Matt chrome-plated tool frame
- Bis zu 200 verschiedene Presseinsätze lieferbar / Up to 200 different crimping inserts available



Inhalt Set / scope of delivery set.

Crimpwerkzeug / crimping tool CT-U

Presseinsatzhalter / crimping insert holder CT-UH

3 auswechselbare Crimpeinsätze / exchangeable crimping dies :

CT-I-02 Aderendhülsen mit + ohne Kragen / ferrules with + without collar 0,5 –16,0 mm<sup>2</sup>

(Art.Nr. / part no.:12800070.02)

CT-I-06 isolierte Kabelschuhe (rot, blau, gelb) / insulated cable lugs (red, blue, yellow) 0,5 –6,0 mm<sup>2</sup>

(Art.Nr. / part no.:12800070.06)

CT-I-08 nicht isolierte Quetsch-Kabelschuhe / non-insulated crimp terminals 0,5 –10,0 mm<sup>2</sup> DIN 46234

(Art.Nr. / part no.:12800070.08)

Typ	Lieferumfang	Koffer	Art.Nr.	€
type	scope of delivery	case	part no.	/Stk. /pc.
CT-U	Crimpwerkzeug ohne Einsätze / crimping tool without inserts	nein / no	12800070	62,20
CT-U-SET	Crimpwerkzeug - Set / crimping tool set	nein / no	12800071	125,00
CT-U-K	Koffer leer (für CT-U und 5 Einsätze)	ja / yes	12800071.1	19,59

Crimpeinsätze siehe folgende Seiten / crimping inserts see following pages

**GOGATool CT-UH Presseinsatzhalterung / crimp insert holder**

Presseinsatzhalterung zur Aufnahme und Transport von bis zu drei Presseinsätzen / crimp insert holder for holding and transporting up to three crimp inserts

Arretierung durch Magnete / Locking by magnets

Lieferumfang ohne Presseinsätze / Scope of delivery without press inserts

Typ	Beschreibung	Art.Nr.	€
type	description	part no.	/pc.
CT-UH	Presseinsatzhalterung / crimping insert holder	12800076	26,25



Preise gültig ab 01.07.2024 exkl. MwSt., freibleibend, **NETTOPREISE /**

prices are valid from 01.07.2024 excl. VAT, subject to change, **NET PRICES**

sonst. Konditionen siehe [www.gogatec.com/AGB.pdf](http://www.gogatec.com/AGB.pdf), techn. Änderungen vorbehalten /

terms & conditions can be found on our website: [www.gogatec.com/AGB.pdf](http://www.gogatec.com/AGB.pdf); error, technical modifications and variations are reserved

**GOGATool CT-I Crimpeinsätze / crimping inserts**

**Crimpeinsätze f. CT-U / Aderendhülsen / crimping inserts f. CT-U / core end sleeves**

Type	Crimpbereich mm <sup>2</sup>	Crimpbereich TWIN mm <sup>2</sup>	Art.Nr.	€
type	crimping section	crimping section	part no.	/pc.
CT-I-01	0,5-6	2 x 0,5 - 4	12800070.01	21,45
CT-I-02	0,5-16	2 x 0,5 - 6	12800070.02	23,57
CT-I-03	16-35	2 x 10, 2 x 16	12800070.03	24,42
CT-I-04	0,25-16	2 x 10, 2 x 16	12800070.04	34,62
CT-I-05	25-50	2 x 10, 2 x 16	12800070.05	34,62



**Crimpeinsätze f. CT-U / isolierte Kabelschuhe, Schrumpf-Verbinder, nicht-isolierte Quetsch-Kabelschuhe DIN 46234, nicht isolierte Stoßverbinder DIN 46237 / crimping inserts f. CT-U / insulated cable lugs, shrink connectors, non-insulated crimp cable lugs DIN 46234, non-insulated butt connectors DIN 46237**

Typ	Verwendung	Crimpbereich mm <sup>2</sup>	Art.Nr.	€
type	usage	crimping section	part no.	/pc.
CT-I-06	isolierte Kabelschuhe / ins. cable lugs	0,5-6	12800070.06	22,14
CT-I-07	Schrumpf-Verbinder / shrink connectors	0,5-6	12800070.07	31,53
CT-I-08	nicht isol. Quetschkabelschuhe DIN 46234 / uninsulated crimping cable lugs DIN 46234	0,5-10	12800070.08	18,94
CT-I-09	nicht isol. Stossverbinder * / unins. butt connectors *	0,5-6	12800070.09	36,85



\* Klauke Normalausführung (Cimco Normalausführung, Weitkowitz Serie Euro mit Einschränkung, da teilweise starke "Ohren"-Bildung bis 0,75 / 1,5 mm<sup>2</sup> Cimco/Weitkowitz) /

Klauke Normal version (Cimco Normal-version, Weitkowitz Series Euro with restriction, because partly strong "ear"-formation up to 0,75 / 1,5 mm<sup>2</sup> Cimco/Weitkowitz)

**Crimpeinsätze f. CT-U / unisolierte Flachstecker / crimping inserts f. CT-U / uninsulated flat plugs**

Typ	für Stecker	Crimpbereich mm <sup>2</sup>	Art.Nr.	€
type	for plug	crimping section	part no.	/pc.
CT-I-10	Flachstecker / flat connector 4,8 / 6,3 mm	0,5 - 2,5	12800070.10	24,42
CT-I-11	Flachstecker / flat connector 4,8 / 6,3 mm	0,5 - 6	12800070.11	25,29
CT-I-12	Fahnen - Flachstecker / flag flat plug 6,3mm	0,5 - 2,5	12800070.12	45,91

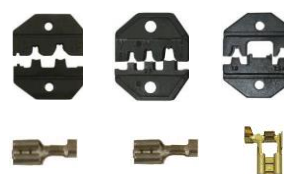

**Crimpeinsätze f. CT-U / SUB-D Stecker Kontakte / crimping inserts f. CT-U / SUB-D plugs contacts**

Typ	für Stecker	Crimpbereich mm <sup>2</sup>	Crimpbereich AWG	Art.Nr.	€
type	for plug	crimping section	crimping section	part no.	/pc.
CT-I-13	Sub-D Stecker 075 / plug	0,05 - 0,75	24-30, 18 - 22	12800070.13	26,45
CT-I-14	Sub-D Stecker 05 / plug	0,08 - 0,5	24 - 28, 20 - 22	12800070.14	26,45



**Crimpeinsätze f. CT-U / 3 mm Glasfaser-Einziehstrang / crimping inserts f. CT-U / 3 mm glass fiber retractable cord**

Type	Verwendung	Art.Nr.	€
type	usage	part no.	/pc.
CT-I-15	Gewindehülse, Stoßverbinder / threaded sleeve, butt connector	12800070.15	30,29



Preise gültig ab 01.01.2024 exkl. MwSt., freibleibend, **NETTOPREISE /**

prices are valid from 01.01.2024 excl. VAT, subject to change, **NET PRICES**

sonst. Konditionen siehe [www.gogatec.com/AGB.pdf](http://www.gogatec.com/AGB.pdf), techn. Änderungen vorbehalten /

terms & conditions can be found on our website: [www.gogatec.com/AGB.pdf](http://www.gogatec.com/AGB.pdf); error, technical modifications and variations are reserved

**Crimpeinsätze f. CT-U / Solar-Stecker / crimping inserts f. CT-U / solar plugs**

Type	für Stecker	Crimpbereich mm <sup>2</sup>	Art.Nr.	€
type	for plug	crimping section	part no.	/Stk. /pc.
CT-I-16	Multi Contact MC3	4 + 6	12800070.16	49,71
CT-I-17	Multi Contact MC4	4 + 6	12800070.17	49,71
CT-I-09	Tyco *	4 + 6	12800070.09	36,85



\* Mit dem Crimpprofil 2,5 mm<sup>2</sup> lassen sich auch die Tyco Stecker 4 + 6 mm<sup>2</sup> verpressen /  
the crimp profile 2.5 mm<sup>2</sup> can also be used to crimp Tyco connectors 4 + 6 mm<sup>2</sup>.

**Crimpeinsätze f. CT-U / Fibre Optic Stecker / crimping inserts f. CT-U / fibre optic plugs**

Type	für Faser Typ	Hexmaße mm	Art.Nr.	€
type	for fibre type	hex dimensions	part no.	/Stk. /pc.
CT-I-19	SMA	5,46 / 4,52 / 3,83	12800070.19	26,66
CT-I-20	SMA, SMB, SFR, ST, SC	3,25 / 3,83 / 5,46 / 5,00 / 4,52	12800070.20	a. A.



a. A. = auf Anfrage / upon request

**Crimpeinsätze f. CT-U / Koax - Stecker / crimping inserts f. CT-U / coax plugs**



Typ	für Stecker	für Kabel Typ	Hexmaße mm	Art.Nr.	€
type	for plug	for cable type	hex dimensions	part no.	/Stk. /pc.
CT-I-21	Koax, BNC/TNC	RG58, RG59, RG62, RG71	6,50 / 5,41 / 1,72	12800070.21	18,94
CT-I-22	Koax, Thinnnet, Mini-UHF, BNC/TNC	RG58, RG174	5,41 / 4,52 / 1,72 / 1,06	12800070.22	20,01
CT-I-23	Koax, BNC/TNC	RG174, RG179, kleine Koax Stecker / small coax plug	4,52 / 3,25 / 1,72	12800070.23	20,01
CT-I-24	SMA, SMB, Mini-59, Mini-UHF, B/TNC	RG58, Mini-59, RG-174	3,25 / 5,41 / 5,00 / 4,52 / 1,72 / 1,06	12800070.24	20,02
CT-I-25	Koax, CATV" F" Typ, BNC/TNC	RG6, RG6 Quad	9,14 / 8,23 / 1,72	12800070.25	20,02
CT-I-26	N-Typ	RG8, RG11	10,89 / 2,54 / 2,03	12800070.26	20,02
CT-I-27	Koax, N-Typ	RG8, RG11, RG213, RG216	10,54 / 2,41	12800070.27	20,01

**Crimpeinsätze f. CT-U / geschirmte WE-Stecker / crimping inserts f. CT-U / shielded WE-plugs**



Typ	für Stecker	für Kabel Typ	Art.Nr.	€
type	for plug	for cable type	part no.	/Stk. /pc.
CT-I-28	RJ45-8P8K, Stewart Connectors	einadrig+flexibel / single wire + flexible	STP22-24 AWG	12800070.28 38,14
CT-I-29	RJ 45 8P8K lang / long , Hirose	einadrig+flexibel / single wire + flexible	STP22-24 AWG	12800070.29 38,14
CT-I-30	RJ 45 -8P8K kurz / short , Hirose	einadrig+flexibel / single wire + flexible	STP22-24 AWG	12800070.30 38,14
CT-I-31	RJ 45 -8P8K, AMP, Molex, f. Ø 6,0 mm	einadrig+flexibel / single wire + flexible	STP22-24 AWG	12800070.31 38,14

Preise gültig ab 01.01.2024 exkl. MwSt., freibleibend, **NETTOPREISE** /

prices are valid from 01.01.2024 excl. VAT, subject to change, **NET PRICES**

sonst. Konditionen siehe [www.gogatec.com/AGB.pdf](http://www.gogatec.com/AGB.pdf), techn. Änderungen vorbehalten /

terms & conditions can be found on our website: [www.gogatec.com/AGB.pdf](http://www.gogatec.com/AGB.pdf); error, technical modifications and variations are reserved

**Crimpeinsätze f. CT-U / ungeschirmte WE-Stecker / crimping inserts f. CT-U / unshielded WE-plugs**



Typ	für Stecker	für Kabel Typ	Art.Nr.	€
type	for plug	for cable type	part no.	/Stk. /pc.
CT-I-32	RJ45-8P8K, Stewart Connectors		12800070.32	25,13
CT-I-33	RJ11& RJ12-6P6K, Stewart Connectors		12800070.33	25,13
CT-I-34	Telefon / phone 4P4K, AMP+ Stewart Con.	einadrig+flexibel, flach+rund /	12800070.34	25,13
CT-I-35	RJ45-8P8K, AMP	single wire + flexible, flat + round STP22-	12800070.35	25,13
CT-I-36	RJ11& RJ12-6P6C, AMP	24 AWG	12800070.36	25,13
CT-I-37	RJ 11 DECMMJ-6P6K, AMP		12800070.37	25,13
CT-I-38	RJ50-10P10K, AMP		12800070.38	25,13

**GOGATool CSQCC**

Die Crimpeinsätze sind ganz einfach zu wechseln und werden durch ein patentiertes Magnetsystem im Handwerkzeug gehalten. /

The crimping inserts are easily to change and are held by a patented magnet system in the hand tool.

**Crimpeinsätze / crimp inserts**

isolierte Kabelschuhe 0,5 – 6mm<sup>2</sup> rot, blau, gelb / insulated cable lugs 0,5 – 6mm<sup>2</sup> red, blue, yellow

unisolierte Kabelschuhe 0,5 – 6mm<sup>2</sup> (Dornpressung) / uninsulated cable lugs 0,5-6mm<sup>2</sup> (arbor pressing)

unisolierte Kabelschuhe 0,5 – 6mm<sup>2</sup> (Fbzw. B-Crimp) / uninsulated cable lugs 0,5-6mm<sup>2</sup> (For B-crimp)

BNC Connectoren RG58 / RG59 / BNC Connectors RG58 / RG59

Aderendhülsen 0,5 – 6mm<sup>2</sup> (Trapezpressung) / core end sleeves 0,5-6mm<sup>2</sup> (trapeze pressing)

Aderendhülsen 10 – 25mm<sup>2</sup> (Trapezpressung) / core end sleeves 10-25mm<sup>2</sup> (trapeze pressing)

**SET:**

Crimpzange / crimping tool

Crimpeinsätze / crimping inserts

Kunststoffkoffer / plastic case

**Patentiertes  
Magnetsystem /  
patented magnet system**



Typ	ArtNr	€
type		/Stk. /pc.
CSQCC-Set	12800033	182,00
weitere Crimpeinsätze / more crimping inserts		35,70

Preise gültig ab 01.01.2024 exkl. MwSt., freibleibend, **NETTOPREISE** /

prices are valid from 01.01.2024 excl. VAT, subject to change, **NET PRICES**

sonst. Konditionen siehe [www.gogatec.com/AGB.pdf](http://www.gogatec.com/AGB.pdf), techn. Änderungen vorbehalten /

terms & conditions can be found on our website: [www.gogatec.com/AGB.pdf](http://www.gogatec.com/AGB.pdf); error, technical modifications and variations are reserved

## GOGATool PEW12

(AKKU-Version siehe E-PEW12)

**Spezialcrimpzange zum Vercrimpen nahezu aller aktuellen Crimpverbinder von 0,08-95mm<sup>2</sup>. /  
Special crimp tool for crimping almost all current crimp connectors with a conductor cross-section of inner 0,08-95mm<sup>2</sup>.  
garantiert exakte, lötfreie, elektrische Verbindungen / guaranteed accurate, solderless, electrical connections  
parallele Crimpbackenzustellung / parallel crimp jaws  
optimale Hebelübersetzung / optimum lever transmission  
gute Handhabung durch ergonomische Schwerpunktlage / good handling because of ergonomic center of gravity  
Ein – und Zweihandbedienung möglich / one – and two-hand operation possible  
vielfältige Kombinationsmöglichkeiten / a variety of combinations**

**Brüniert mit 2k-Griffen, ohne Crimpeinsatz / burnished with 2khandles, without inserts**

Typ	Länge mm	Gewicht g	Koffer	Art.Nr.	€ /Stk.
type	length	weight	case	part no.	/pc.
PEW12	200	975	ja / yes	12800001	152,00
PEW12-70	200	975	nein / no	12800001.4	219,00



Crimpeinsätze siehe unten und folgende Seiten /  
crimping inserts see below and following pages

**PEW12-70 ohne.  
Crimp-Einsatz für  
70/95 mm<sup>2</sup> /  
PEW12-70 excl. crimp-insert  
for 70 and 95mm<sup>2</sup>**



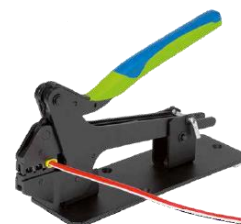

**Tischhalterung für PEW12 / tabletop mount for PEW12**

Typ	Länge mm	Gewicht g	Art.Nr.	€ /Stk.
type	length	weight	part no.	/pc.
Tischhalterung / tabletop mount	190	360	12800001.54	65,40



**Crimpeinsätze f. PEW12 / isolierte Kabelschuhe / crimp inserts f. PEW12 / insulated cable lugs  
DIN 46237**

\* auch f. Flachstecker geeignet / also suitable for flat connectors

Typ	Crimpbereich mm <sup>2</sup>	Profil	Art.Nr.	€ /Stk.
type	crimping section	profile	part no.	/pc.
CEIKS1*	0,5-1,0		12800001.07	59,00
	1,5-2,5			
	4,0-6,0			
CEIKS2 Schrumpfschlauch / shrinking tubes	0,5-1,0		12800001.08	59,30
	1,5-2,5			
	4,0-6,0			
CEIKS3	10		12800001.21	62,00
	16			
CEIKS4 konisch / conical *	0,5-1,0		12800001.22	58,50
	1,5-2,5			
	4,0-6,0			



Preise gültig ab 01.01.2024 exkl. MwSt., freibleibend, **NETTOPREISE** /

prices are valid from 01.01.2024 excl. VAT, subject to change, **NET PRICES**

sonst. Konditionen siehe [www.gogatec.com/AGB.pdf](http://www.gogatec.com/AGB.pdf), techn. Änderungen vorbehalten /

terms & conditions can be found on our website: [www.gogatec.com/AGB.pdf](http://www.gogatec.com/AGB.pdf); error, technical modifications and variations are reserved

**Crimpeinsätze f. PEW12 / unisolierte Kabelschuhe / crimp inserts f. PEW12 / uninsulated cable lugs**  
**DIN 46234 / 46235 / 46267**

Typ type	Crimpbereich mm <sup>2</sup> crimping section	Profil profile	Verbinder connectors	Art.Nr. part no.	€/Stk. /pc.
CEUKS1	0,5-0,75			12800001.23	58,60
	1,0-1,5				
	2,5				
CEUKS2	4,0			12800001.24	57,20
	6,0				
	10				
CEUKS3	1,5			12800001.25	57,20
	2,5				
	4,0				
	6,0				
CEUKS4	10,0			12800001.26	57,20
	0,5-1,0				
	1,5-2,5				
	4,0-6,0				
CEUKS5	16,0			12800001.27	60,50
	25,0				
Kombi-Einsatz / combi-insert	0,5-1,5			12800001.45	57,20
	1,5-2,5				
	4,0-6,0				
	6,0-10,0				

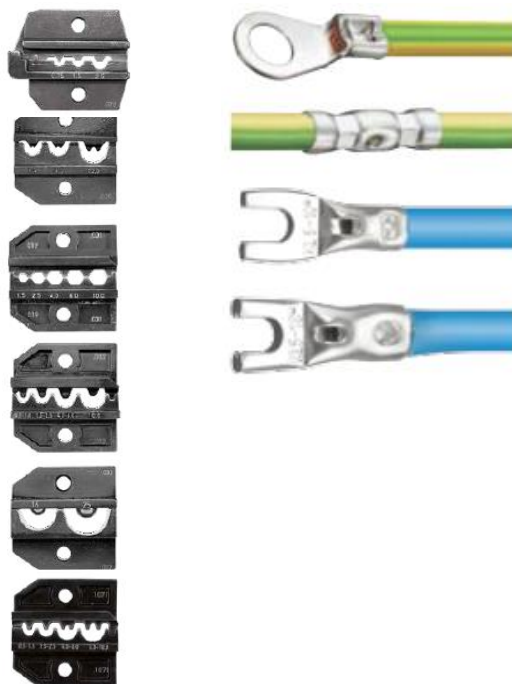

**Crimpeinsätze f. PEW12 / Flachstecker / crimp inserts f. PEW12 / flat connectors**  
**DIN 46247 / 46345 / 46346**

Typ type	Crimpbereich mm <sup>2</sup> crimping section	Profil profile	Verbinder connector	Art.Nr. part no.	€/Stk. /pc.
CEFS1	0,1-0,25			12800001.11	113,00
	0,5-1,0				
	0,5-1,0				
	1,5-2,5				
CEFS2	0,5-1,0			12800001.12	109,90
	1,5-2,5				
	4,0-6,0				
CEFS3	0,5-1,0			12800001.28	196,00
	0,5-1,0				
	1,25-2,5				
CEFS4	1,25-2,5			12800001.29	200,00
	3,0-4,0				
	4,0-6,0				
CEKA1	Positionierhilfe für CEFS1		-	12800001.30	36,11
CEKA2	Positionierhilfe für CEFS2		-	12800001.31	35,80

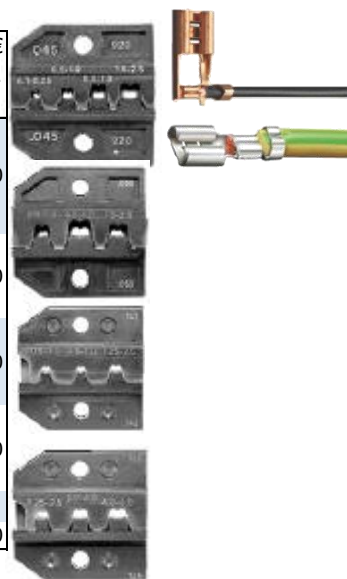

**Crimpeinsätze f. PEW12 / gerollte u. gestanzte Kontakte / crimp inserts f. PEW12 / rolled a. stamped contacts**

Typ type	Kontaktart connector type	Crimpbereich mm <sup>2</sup> crimping section	Profil profile	Verbinder connector	Art.Nr. part no.	€/Stk. /pc.
Einsatz / insert	Junior P. Timer	0,5-1,0 0,5-1,0 1,5-2,5 1,5-2,5			12800001.39	138,60

















Preise gültig ab 01.01.2024 exkl. MwSt., freibleibend. **NETTOPREISE /**

prices are valid from 01.01.2024 excl. VAT, subject to change. **NET PRICES**

sonst. Konditionen siehe [www.gogatec.com/AGB.pdf](http://www.gogatec.com/AGB.pdf), techn. Änderungen vorbehalten /

terms & conditions can be found on our website: [www.gogatec.com/AGB.pdf](http://www.gogatec.com/AGB.pdf); error, technical modifications and variations are reserved



















Crimpeinsätze f. PEW12 / Aderendhülsen / crimp inserts f. PEW12 / core end sleeves

Type	Crimpbereich mm <sup>2</sup>	Profil	Verbinder	Art.Nr.	€
type	crimping section	profile	connectors	part no.	/Stk. /pc.
CEAH1	0,25-0,75			12800001.32	57,20
	1,0-1,5				
	2,5				
	4,0				
	6,0				
CEAH2	0,5-1,0			12800001.33	106,80
	1,5				
CEAH3	10			12800001.34	57,20
	16				
	25				
CEAH4	35			12800001.35	95,90
	50				
CEAH5	2x6			12800001.36	102,20
	2x10				
	2x16				
CEAH6*	70			12800001.37	115,80
CEAH7*	95			12800001.38	115,80



\* = NUR mit 12800001.4 kompatibel / only compatible with 12800001.4

Crimpeinsätze f. PEW12 / gedrehte Kontakte / crimp inserts f. PEW12 / turned contacts

Typ	Crimpbereich mm <sup>2</sup>	Steckdurchmesser mm	Profil	Verbinder	Abbildung	Art.Nr.	€
type	crimping section	plug in diameter	profile	connector	image	part no.	/Stk. /pc.
Kontakt- aufnahme / locator	0,14-1,0	1,6				12800001.17	112,60
	1,5	2,4					
	2,5	2,5					
	4						
Einsatz / insert	0,14-1,0	1,6				12800001.18	144,30
	1,5	2,4					
	2,5	2,5					
Einsatz / insert	1,5	4,0				12800001.19	141,10
	2,5						
	4						
Einsatz / insert	4	3,6				12800001.20	137,10
	6						
Einsatz + Kontaktaufn./ insert + locator	10	5,0				12800001.67	a. A.
	16						
Einsatz + Kontaktaufn./ insert + locator	6	5,0				12800001.68	a. A.
	25						



a. A. = auf Anfrage / upon request





Preise gültig ab 01.01.2024 exkl. MwSt., freibleibend, **NETTOPREISE** /

prices are valid from 01.01.2024 excl. VAT, subject to change, **NET PRICES**

sonst. Konditionen siehe [www.gogatec.com/AGB.pdf](http://www.gogatec.com/AGB.pdf), techn. Änderungen vorbehalten /



terms & conditions can be found on our website: [www.gogatec.com/AGB.pdf](http://www.gogatec.com/AGB.pdf); error, technical modifications and variations are reserved

**Crimpeinsätze f. PEW12 / Solarverbinder / crimp inserts f. PEW12 / turned contacts**  
**Multifunktion / multifunctional : Schneiden, Abisolieren, Crimpen / cutting, stripping, crimping**

Typ <i>type</i>	Crimpbereich mm <sup>2</sup> <i>crimping section</i>	Profil <i>profile</i>	Verbinder <i>connector</i>	Art.Nr. <i>part no.</i>	€ /Stk. <i>/pc.</i>
Kontakt- aufnahme / <i>locator</i>	4 6			12800001.62	68,30
Einsatz / <i>insert</i>	4			12800001.50	237,00
Einsatz / <i>insert</i>	6			12800001.52	409,00











**Crimpeinsätze f. PEW12 / Solarverbinder / crimp inserts f. PEW12 / turned contacts**

Typ <i>type</i>	Crimpbereich mm <sup>2</sup> <i>crimping section</i>	Profil <i>profile</i>	Verbinder <i>connector</i>	Art.Nr. <i>part no.</i>	€ /Stk. <i>/pc.</i>
Einsatz / <i>insert</i>	4 6 10			12800001.53	141,10





**Crimpeinsätze f. PEW12 / Datenstecker / crimp inserts f. PEW12 / data plugs**

Typ <i>type</i>	Steckertyp <i>plug type</i>	Profil <i>profile</i>	Verbinder <i>connector</i>	Art.Nr. <i>part no.</i>	€ /Stk. <i>/pc.</i>
Einsatz / <i>insert</i>	RJ 9,10,11,12,45 Westernstecker / <i>western jack</i> 4,6,8 polig / <i>pin</i>			12800001.63	a. A.
Einsatz / <i>insert</i>	Molexstecker (kurze Bauform) / <i>molex jacks (short)</i> 4,6,8 polig / <i>pin</i>			12800001.64	a. A.
Einsatz / <i>insert</i>	RJ 45 / 50 Westernstecker / <i>western jacks</i> 4,6,10 polig / <i>pin</i>			12800001.65	193,00
Einsatz / <i>insert</i>	Stewart-Verbinder / <i>stewart plugs</i> 4,6,8 polig / <i>pin</i>			12800001.66	a. A.

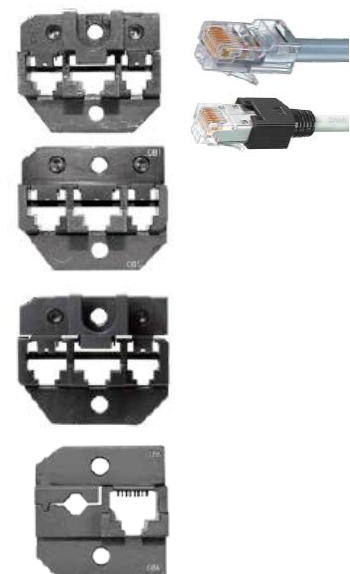
a. A. = auf Anfrage / upon request



**Crimpeinsätze f. PEW12 / Koaxverbinder / crimp inserts f. PEW12 / coaxial connectors**

Typ <i>type</i>	Kabelbez. <i>cable designation</i>	Crimpmaß mm <i>crimp size</i>	Crimphülßen Ø mm <i>sleeve diameter</i>	Profil <i>profile</i>	Verbinder <i>connector</i>	Art.Nr. <i>part no.</i>	€ /Stk. <i>/pc.</i>
Einsatz / <i>insert</i>	RG 58 RG 178 RG 316 RG 188	3,25 4,52 5,4 1,72 1,07	3,9 5,4 6,4 2,1 1,3 0,95			12800001.61	113,10

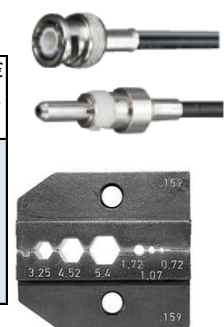

Preise gültig ab 01.01.2024 exkl. MwSt., freibleibend, **NETTOPREISE /**  
 prices are valid from 01.01.2024 excl. VAT, subject to change, **NET PRICES**  
 sonst. Konditionen siehe [www.gogatec.com/AGB.pdf](http://www.gogatec.com/AGB.pdf), techn. Änderungen vorbehalten /  
 terms & conditions can be found on our website: [www.gogatec.com/AGB.pdf](http://www.gogatec.com/AGB.pdf); error, technical modifications and variations are reserved



**GOGATool E-PEW 12 Elektrische-Crimpzange / electrical crimping pliers**

geringe Störanfälligkeit, lange Wartungsintervalle / low susceptibility to interference, long service intervals  
 Motorschnellstopp (kein Nachlauf) / motor quick-stop (no tracking)  
 Tippbetrieb für exakte Positionierung der Kontakte / jog mode for exact positioning of the contacts  
 Notentriegelung und Reset-Funktion / emergency release and reset function  
 geringe Lautstärke / low volume  
 Warnfunktion gegen Überhitzung und Überlastung / warning function against overheating and overloading  
 LED-Beleuchtung des Arbeitsbereiches / LED lighting work

Diese Crimpzange ist elektromechanisch angetrieben und arbeitet mit Li-Ionen-Technologie. Die Zange ist akkubetrieben und ist mit allen verfügbaren Crimpeinsätzen, Positionierhilfen, Drahtanschlüssen etc. der PEW12 Crimpzange kombinierbar (ausgenommen Aderendhülsen 70 und 95 mm<sup>2</sup>). Für die Prozessüberwachung ist eine Multifunktionsanzeige eingebaut. Die Crimpzange weist eine kurze und kompakte Bauweise auf. Das Werkzeug wird ohne Crimpeinsatz und Kontaktaufnahme geliefert. Akku-Ladegerät und Inbusschlüssel werden mitgeliefert, Auslieferung im Kunststoffkoffer. /  
 This crimping tool is driven electromechanically and is working with Li-ion technology. The forceps is battery operated and can be combined with all available crimping dies, positioning, wire attacks etc. from the PEW12 (except ferrules 70 and 95 mm<sup>2</sup>). For process monitoring a multi-function display is fitted. The crimping tool has a short and compact design on. The tool is delivered without crimping tools and touching tool. Battery Charger and Allen are supplied, delivered in a plastic case.



**Crimpbereich / crimping:** Aderendhülsen 0,08 – 50 mm<sup>2</sup> / cable sleeves  
**Pressdruck / pressure:** 10 kN  
**LED-Anzeige / LED display:** Ladezustand Akku, Serviceintervall, Überhitzung/Überlastung / battery charging status, service interval, overheating/overload  
**Gewicht / weight:** 1,95 kg  
**Abmessungen / dimensions:** Zange 274 x 50 x 142 mm, Kunststoffkoffer 500 x 420 x 125 mm / pliers 274 x 50 x 142 mm, plastic case 500 x 420 x 125 mm

**Nach 25.000 Pressungen muss die Zange zum Service. / After 25.000 pressings the pliers must be serviced.  
 Sie schaltet ab und kann nicht mehr betätigt werden. / She switches off and can no longer be operated.**

Typ	Beschreibung	Gewicht	Art.Nr.	€
type	description	kg	part no.	/Stk.
E-PEW12	Crimpzange im Koffer mit Ladegerät EU (ohne Gesenke) / crimping pliers in case with charger EU (without dies)	4,7	12800003	1 889,00
	Li-Ionen-Akku 12 V/1,5 Ah / Li-ion battery 12 V/1,5 Ah	0,18	12800001.2	a. A.
	Li-Ionen-Akku 12 V/3 Ah / Li-ion battery 12 V/3 Ah	0,4	12800001.3	a. A.

a. A. = auf Anfrage / upon request

Preise gültig ab 01.01.2024 exkl. MwSt., freibleibend, **NETTOPREISE** /  
 prices are valid from 01.01.2024 excl. VAT, subject to change, **NET PRICES**  
 sonst. Konditionen siehe [www.gogatec.com/AGB.pdf](http://www.gogatec.com/AGB.pdf), techn. Änderungen vorbehalten /  
 terms & conditions can be found on our website: [www.gogatec.com/AGB.pdf](http://www.gogatec.com/AGB.pdf); error, technical modifications and variations are reserved

Automatisch mit Zwangssperre und Entriegelungsmöglichkeit / automatic with integral lock and release option

Gewicht / weight: 0,8 kg

Länge / length: 335 mm

## GOGATool EAP 51

für ausgedünnte (verdichtete) feindrähtige Leiter / for thinned (compressed) fine wire lines

Crimpbereich / crimp range: 10 – 50 mm<sup>2</sup>

Crimpstationen / crimp stations: 5

Crimpform / crimping form: Trapez mit Einkerbung / trapeze with notch

Typ	Crimpbereich mm <sup>2</sup>	ArtNr	€/Stk.
type	crimp section		/pc.
EAP-51	10/16/25/35/50	12800025	327,00

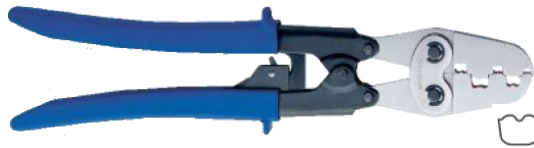

## GOGATool EAP 96

für ausgedünnte (verdichtete) feindrähtige Leiter / for thinned (compressed) fine wire lines

Crimpbereich / crimp range: 50 – 95 mm<sup>2</sup>

Crimpstationen / crimp stations: 3

Crimpform / crimping form: Trapez mit Einkerbung / trapeze with notch

Typ	Crimpbereich mm <sup>2</sup>	ArtNr	€/Stk.
type	crimp section		/pc.
EAP-96	50/70/95	12800027	265,00



Preise gültig ab 01.01.2024 exkl. MwSt., freibleibend, **NETTOPREISE** /

prices are valid from 01.01.2024 excl. VAT, subject to change, **NET PRICES**

sonst. Konditionen siehe [www.gogatec.com/AGB.pdf](http://www.gogatec.com/AGB.pdf), techn. Änderungen vorbehalten /

terms & conditions can be found on our website: [www.gogatec.com/AGB.pdf](http://www.gogatec.com/AGB.pdf); error, technical modifications and variations are reserved